

Trail 22x30

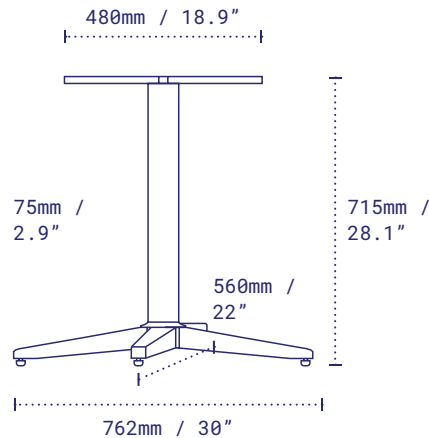









B2230NR-STD : DINING HEIGHT



Trail 22x30 self-stabilising table base ensures a smooth experience for booth seating requiring rectangular tabletops. Trail 22x30 seamlessly complements the entire NOROCK range while perfectly matching our other Trail bases.

Pictured: Trail 22x30 Dining Height, Sandstone Black.

DETAILS

 Material	Steel – Zinc Plated Legs, Zinc Phosphate Column and Top Plate
 Next-Level Protection also available	Steel – Zinc Plated Legs, Zinc Plated Column, Zinc Phosphate Top Plate
 Height excl. table top	715mm / 28.1"
 Base diameter	560 x 762mm / 22 x 30"
 Column width	75mm / 2.9"
 Top plate	Fixed
 Net weight	9.6kg / 21.2lbs
 Max recommended table top	 700 x 1220mm - 28 x 48"
 Resources	

PACKAGING

 **Carton** 570 x 640 x 100mm
/ 22 x 25 x 4" x
Box 1

 **Gross weight** 10.5kg / 23.1lbs

STANDARD COLOR RANGE

 Sandstone Black

