

KRATOS

PROJECT NAME: _____

LOCATION: _____

ITEM #: _____ QTY: _____

MODEL: _____

UNDERBAR SINKS



FEATURES

- STURDY 18 GAUGE, 304 STAINLESS STEEL BODY WITH 16 GAUGE GALVANIZED LEGS
- 10" DEEP BOWLS FOR TALL GLASSES AND PITCHERS
- 30" WORKING HEIGHT WITH A 3" BACKSPLASH
- 1 1/2" IPS DRAIN CONNECTIONS
- SINKS ARE MADE OF 18 GAUGE STAINLESS STEEL WITH 16 GAUGE GALVANIZED LEGS
- LEGS HAVE CROSS BRACES FOR ADDED STABILITY
- COMPATIBLE FAUCET (29N-038) SOLD SEPARATELY



SPECIFICATIONS

ITEM	WIDTH	DEPTH	HEIGHT	COMPARTMENTS	SINK BOWL (LXWXH)	DRAINBOARD LOCATION	DRAINBOARD SIZE
29N-025	14.5"	18.75"	33"	1	10"X14"X5"	N/A	N/A
29N-026	24"	18.75"	33"	1	10"X14"X10"	LEFT	12"
29N-027	24"	18.75"	33"	1	10"X14"X10"	RIGHT	12"
29N-028	36"	18.75"	33"	1	10"X14"X10"	L/R	13" EACH
29N-029	26"	18.75"	33"	2	10"X14"X10"	N/A	N/A
29N-030	36"	18.75"	33"	2	10"X14"X10"	LEFT	12"
29N-031	36"	18.75"	33"	2	10"X14"X10"	RIGHT	12"
29N-032	48"	18.75"	33"	2	10"X14"X10"	L/R	13" EACH
29N-033	38.5"	18.75"	33"	3	10"X14"X10"	N/A	N/A
29N-034	48"	18.75"	33"	3	10"X14"X10"	LEFT	12"
29N-035	48"	18.75"	33"	3	10"X14"X10"	RIGHT	12"
29N-036	60"	18.75"	33"	3	10"X14"X10"	L/R	13" EACH
29N-037	72"	18.75"	33"	4	10"X14"X10"	L/R	13" EACH

KRATOS

PROJECT NAME: _____

LOCATION: _____

ITEM #: _____ QTY: _____

MODEL: _____

29N-025

- 18 GA. 304 S/S TOP BOWL AND BACK #3 POL
- 20 GA. 304S/S APRON
- LEGS - 16 GA. 1-5/8 DIA. GALV. TUBING
- 1-1/4 DIA. GALV. CROSS PIPE
- FEET - PLASTIC ADJUSTABLE BULLET FEET
- ALL SEAMS WELDED & POLISHED
- NO BURRS OR SHARP EDGES
- MEETS NSF STD. 2
- 3" BACKSPLASH
- 1-1/2" DRAIN BASKET INCLUDED

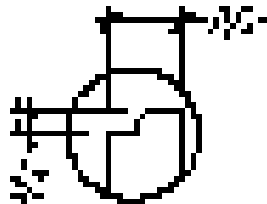
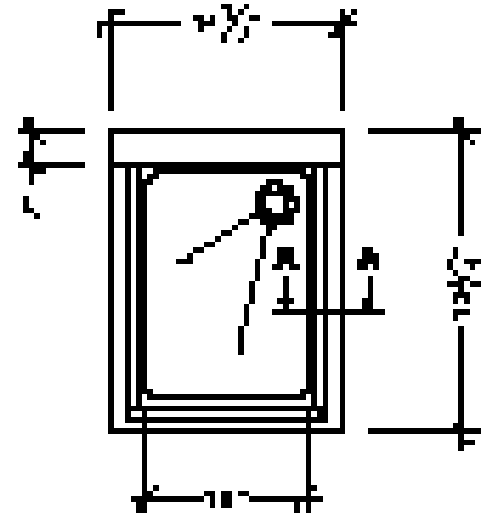

3PC 1 0 4 A.A

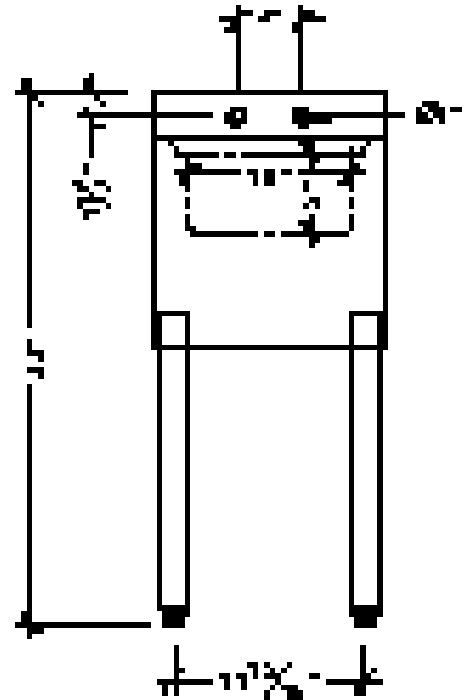
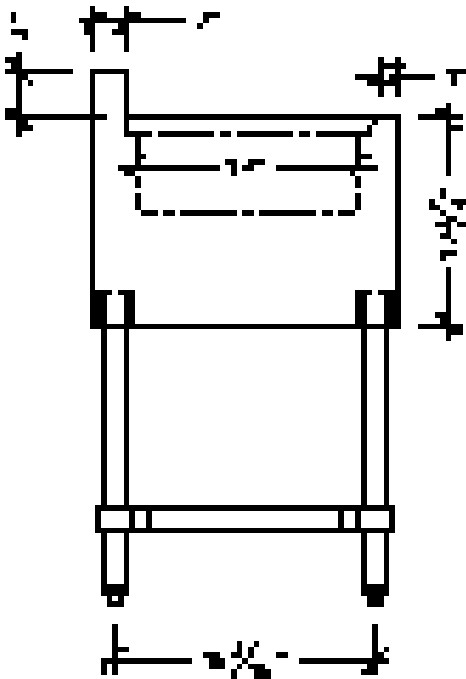

KRATOS

PROJECT NAME: _____

LOCATION: _____

ITEM #: _____ QTY: _____

MODEL: _____

29N-026

- 18 GA. 304 S/S TOP BOWL AND BACK #3 POL
- 20 GA. 304S/S APRON
- LEGS -16 GA. 1-5/8 DIA. GALV. TUBING
- 1-1/4 DIA. GALV. CROSS PIPE
- FEET - PLASTIC ADJUSTABLE BULLET FEET
- ALL SEAMS WELDED & POLISHED
- NO BURRS OR SHARP EDGES
- MEETS NSF STD. 2
- 3" BACKSPLASH
- 1-1/2" DRAIN BASKET INCLUDED

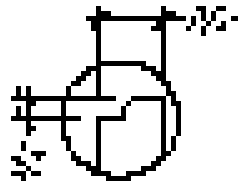
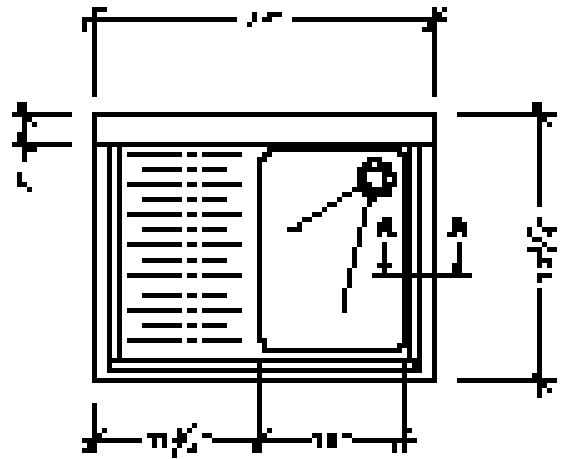

SECTION A-A

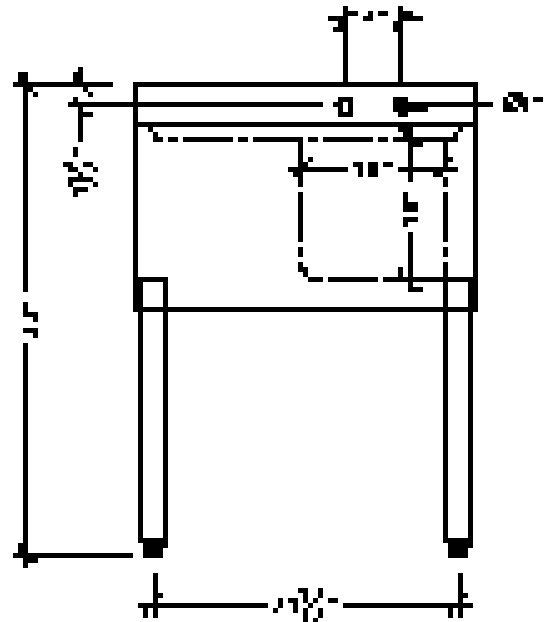
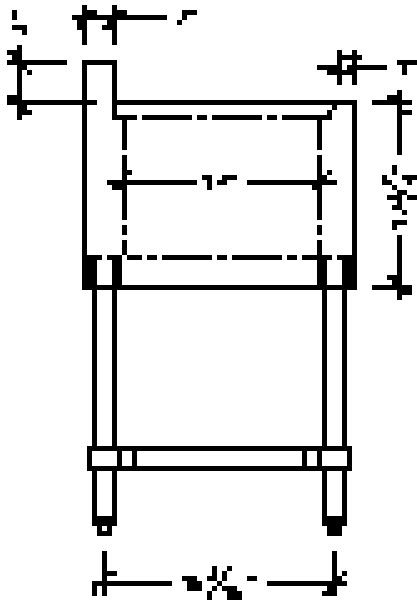

KRATOS

PROJECT NAME: _____
LOCATION: _____
ITEM #: _____ QTY: _____
MODEL: _____

29N-027

- 18 GA. 304 S/S TOP BOWL AND BACK #3 POL
- 20 GA. 304S/S APRON
- LEGS -16 GA. 1-5/8 DIA. GALV. TUBING
- 1-1/4 DIA. GALV. CROSS PIPE
- FEET - PLASTIC ADJUSTABLE BULLET FEET
- ALL SEAMS WELDED & POLISHED
- NO BURRS OR SHARP EDGES
- MEETS NSF STD. 2
- 3" BACKSPLASH
- 1-1/2" DRAIN BASKET INCLUDED

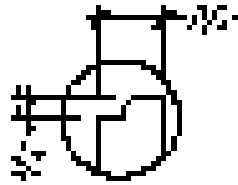
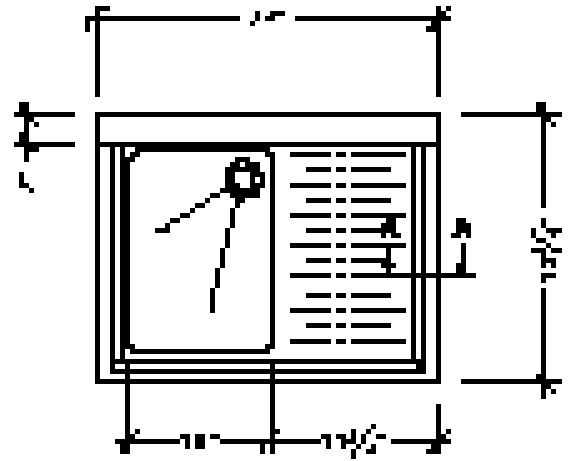

316104 3/4

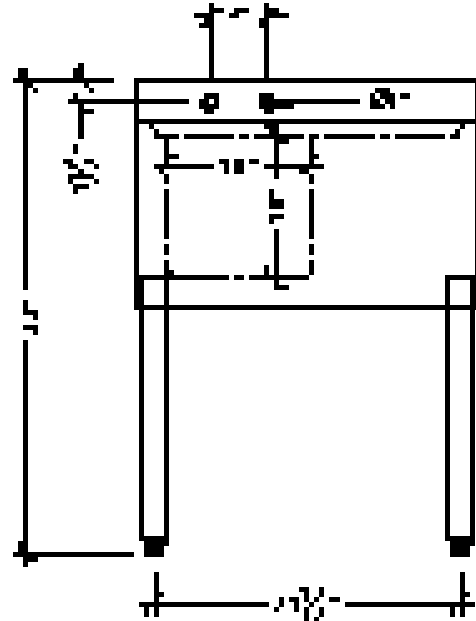
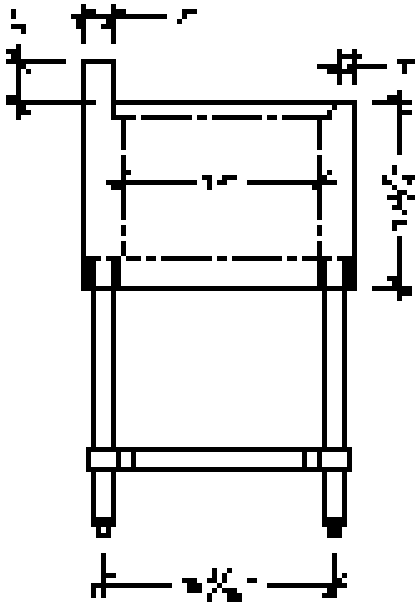

KRATOS

PROJECT NAME: _____
LOCATION: _____
ITEM #: _____ QTY: _____
MODEL: _____

29N-028

- 18 GA. 304 S/S TOP BOWL AND BACK #3 POL
- 20 GA. 304S/S APRON
- LEGS -16 GA. 1-5/8 DIA. GALV. TUBING
- 1-1/4 DIA. GALV. CROSS PIPE
- FEET - PLASTIC ADJUSTABLE BULLET FEET
- ALL SEAMS WELDED & POLISHED
- NO BURRS OR SHARP EDGES
- MEETS NSF STD. 2
- 3" BACKSPLASH
- 1-1/2" DRAIN BASKET INCLUDED

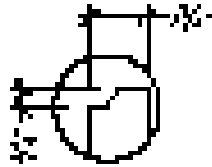
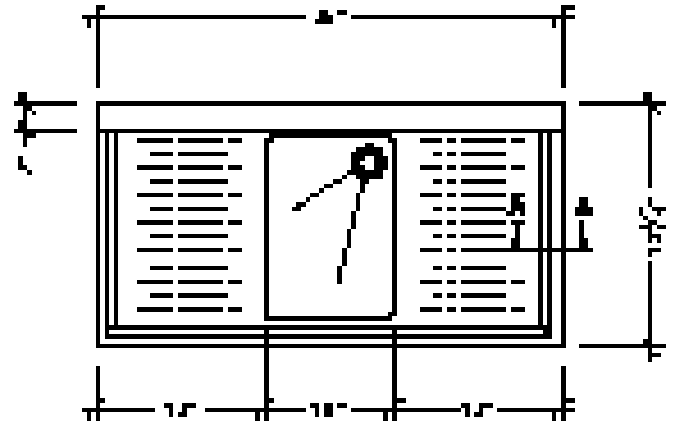

SECTION A-A

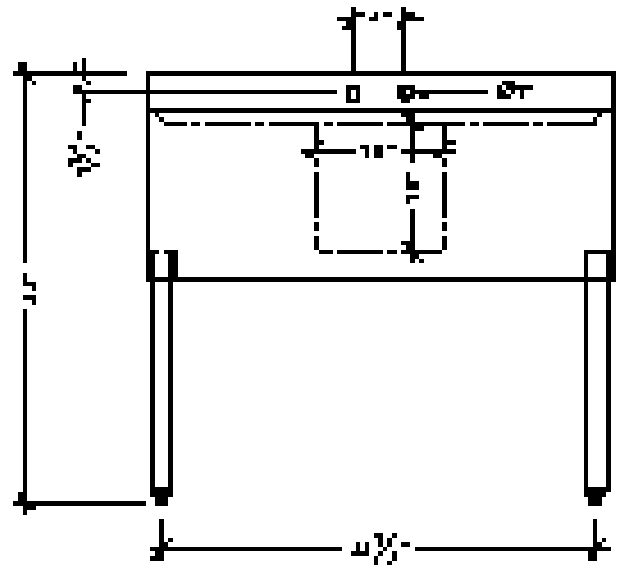
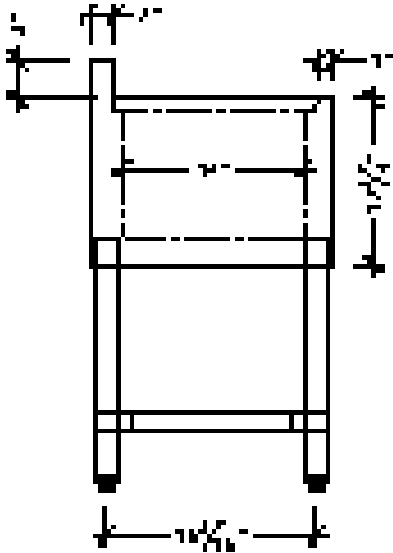

KRATOS

PROJECT NAME: _____

LOCATION: _____

ITEM #: _____ QTY: _____

MODEL: _____

29N-029

- 18 GA. 304 S/S TOP BOWL AND BACK #3 POL
- 20 GA. 304S/S APRON
- LEGS -16 GA. 1-5/8 DIA. GALV. TUBING
- 1-1/4 DIA. GALV. CROSS PIPE
- FEET - PLASTIC ADJUSTABLE BULLET FEET
- ALL SEAMS WELDED & POLISHED
- NO BURRS OR SHARP EDGES
- MEETS NSF STD. 2
- 3" BACKSPLASH
- 1-1/2" DRAIN BASKET INCLUDED

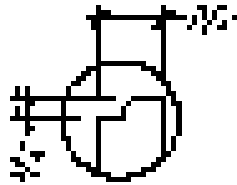

SECTION A-A

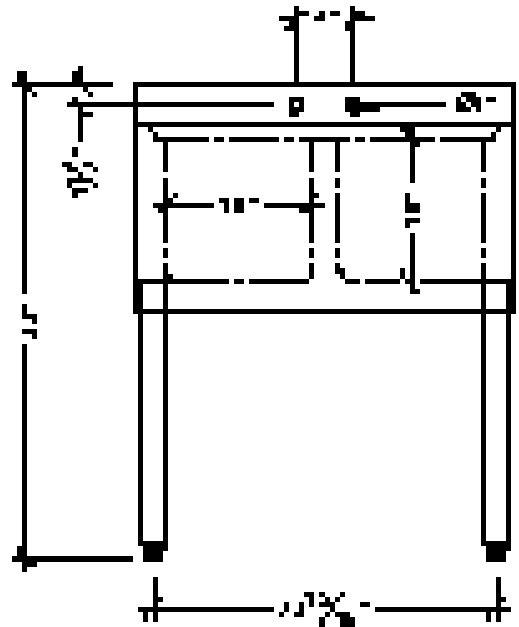
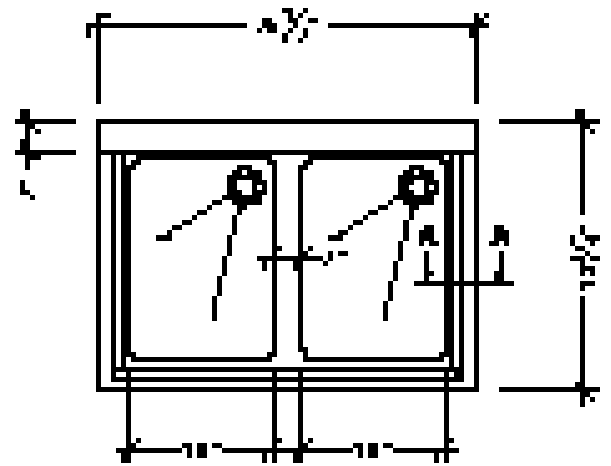
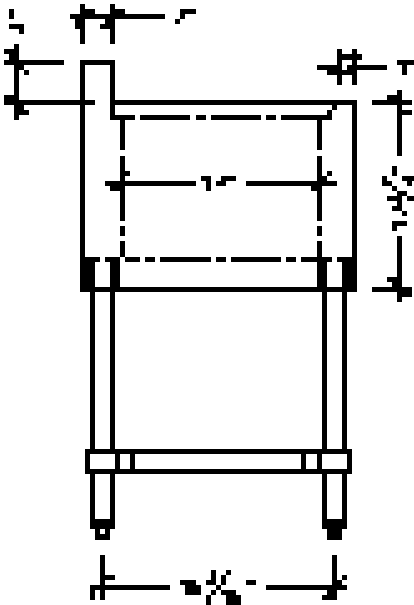

KRATOS

29N-031

PROJECT NAME: _____
LOCATION: _____
ITEM #: _____ QTY: _____
MODEL: _____

- 18 GA. 304 S/S TOP BOWL AND BACK #3 POL
- 20 GA. 304S/S APRON
- LEGS -16 GA. 1-5/8 DIA. GALV. TUBING
- 1-1/4 DIA. GALV. CROSS PIPE
- FEET - PLASTIC ADJUSTABLE BULLET FEET
- ALL SEAMS WELDED & POLISHED
- NO BURRS OR SHARP EDGES
- MEETS NSF STD. 2
- 3" BACKSPLASH
- 1-1/2" DRAIN BASKET INCLUDED

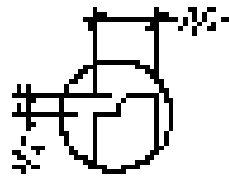
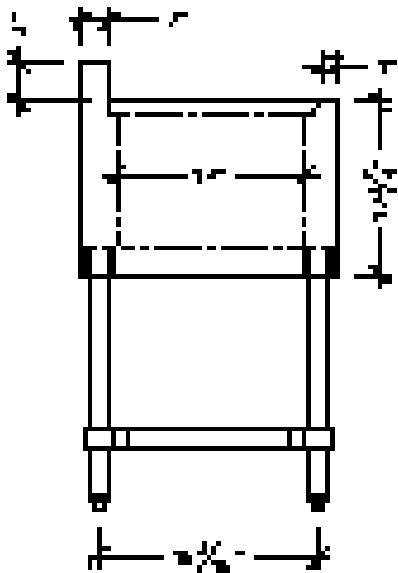

SECTION A-A

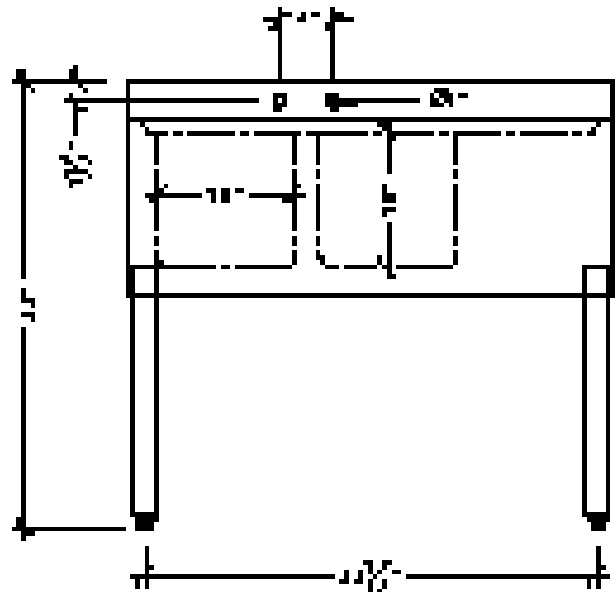
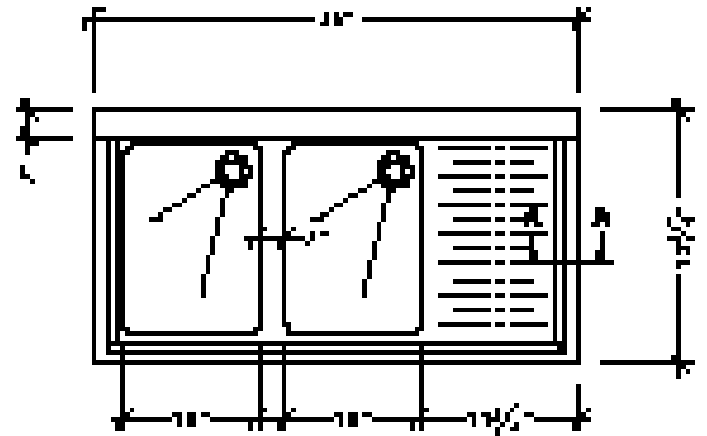

KRATOS

PROJECT NAME: _____

LOCATION: _____

ITEM #: _____ QTY: _____

MODEL: _____

29N-032

- 18 GA. 304 S/S TOP BOWL AND BACK #3 POL
- 20 GA. 304S/S APRON
- LEGS -16 GA. 1-5/8 DIA. GALV. TUBING
- 1-1/4 DIA. GALV. CROSS PIPE
- FEET - PLASTIC ADJUSTABLE BULLET FEET
- ALL SEAMS WELDED & POLISHED
- NO BURRS OR SHARP EDGES
- MEETS NSF STD. 2
- 3" BACKSPLASH
- 1-1/2" DRAIN BASKET INCLUDED

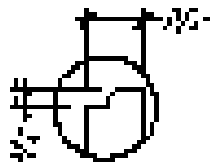
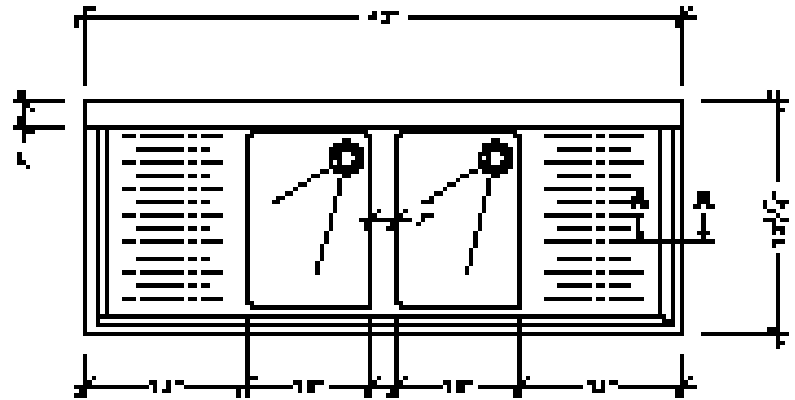

SECTION A-A

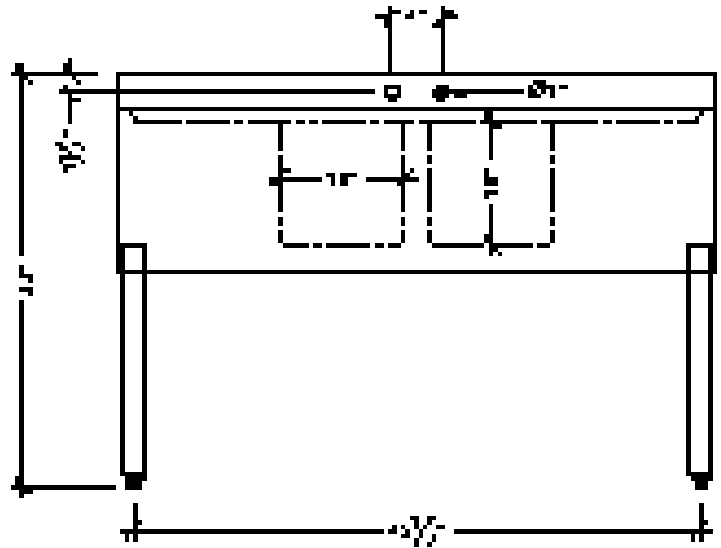
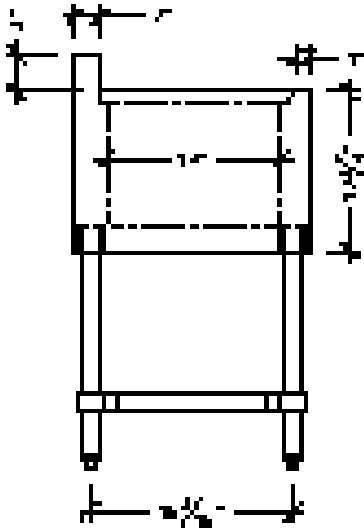

KRATOS

PROJECT NAME: _____

LOCATION: _____

ITEM #: _____ QTY: _____

MODEL: _____

29N-033

- 18 GA. 304 S/S TOP BOWL AND BACK #3 POL
- 20 GA. 304S/S APRON
- LEGS -16 GA. 1-5/8 DIA. GALV. TUBING
- 1-1/4 DIA. GALV. CROSS PIPE
- FEET - PLASTIC ADJUSTABLE BULLET FEET
- ALL SEAMS WELDED & POLISHED
- NO BURRS OR SHARP EDGES
- MEETS NSF STD. 2
- 3" BACKSPLASH
- 1-1/2" DRAIN BASKET INCLUDED

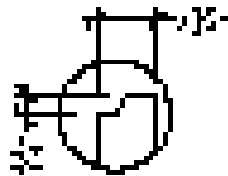
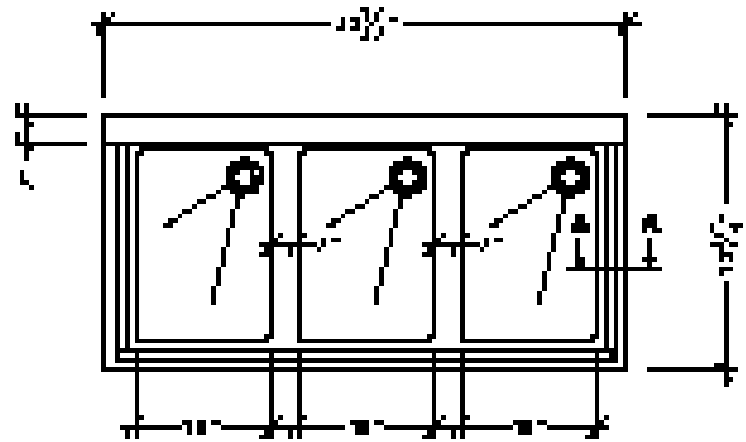

SECTION A-A

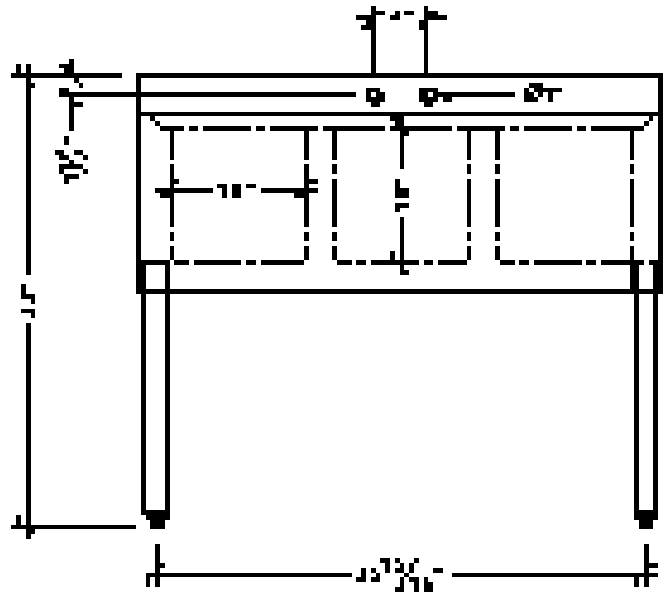
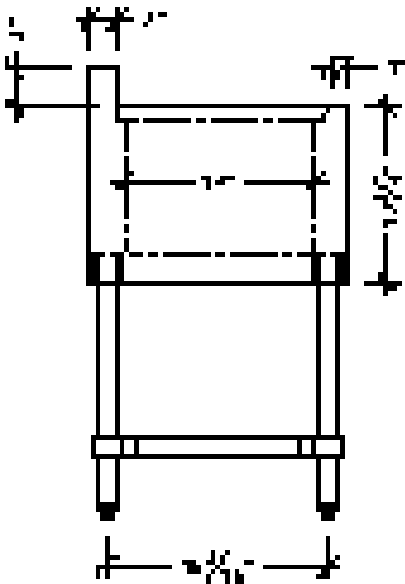

KRATOS

PROJECT NAME: _____

LOCATION: _____

ITEM #: _____ QTY: _____

MODEL: _____

29N-034

- 18 GA. 304 S/S TOP BOWL AND BACK #3 POL
- 20 GA. 304S/S APRON
- LEGS -16 GA. 1-5/8 DIA. GALV. TUBING
- 1-1/4 DIA. GALV. CROSS PIPE
- FEET - PLASTIC ADJUSTABLE BULLET FEET
- ALL SEAMS WELDED & POLISHED
- NO BURRS OR SHARP EDGES
- MEETS NSF STD. 2
- 3" BACKSPLASH
- 1-1/2" DRAIN BASKET INCLUDED

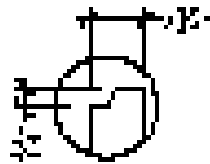
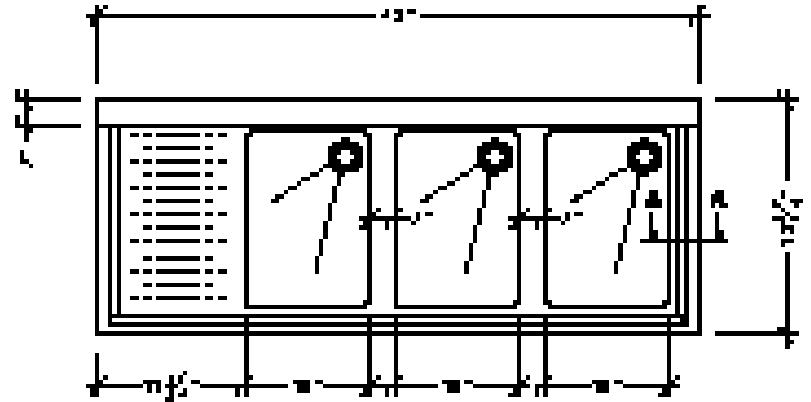

SECTION A-A

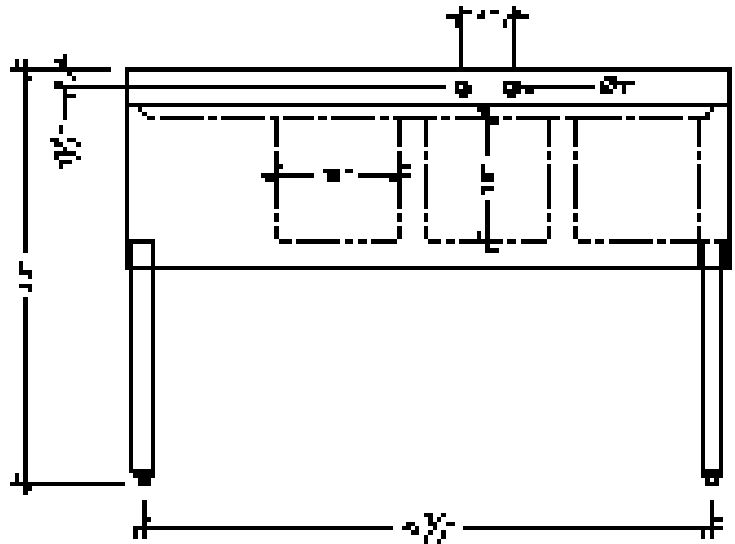
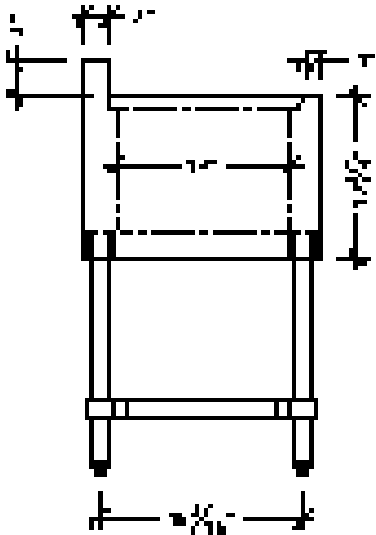

KRATOS

PROJECT NAME: _____

LOCATION: _____

ITEM #: _____ QTY: _____

MODEL: _____

29N-035

- 18 GA. 304 S/S TOP BOWL AND BACK #3 POL
- 20 GA. 304S/S APRON
- LEGS -16 GA. 1-5/8 DIA. GALV. TUBING
- 1-1/4 DIA. GALV. CROSS PIPE
- FEET - PLASTIC ADJUSTABLE BULLET FEET
- ALL SEAMS WELDED & POLISHED
- NO BURRS OR SHARP EDGES
- MEETS NSF STD. 2
- 3" BACKSPLASH
- 1-1/2" DRAIN BASKET INCLUDED

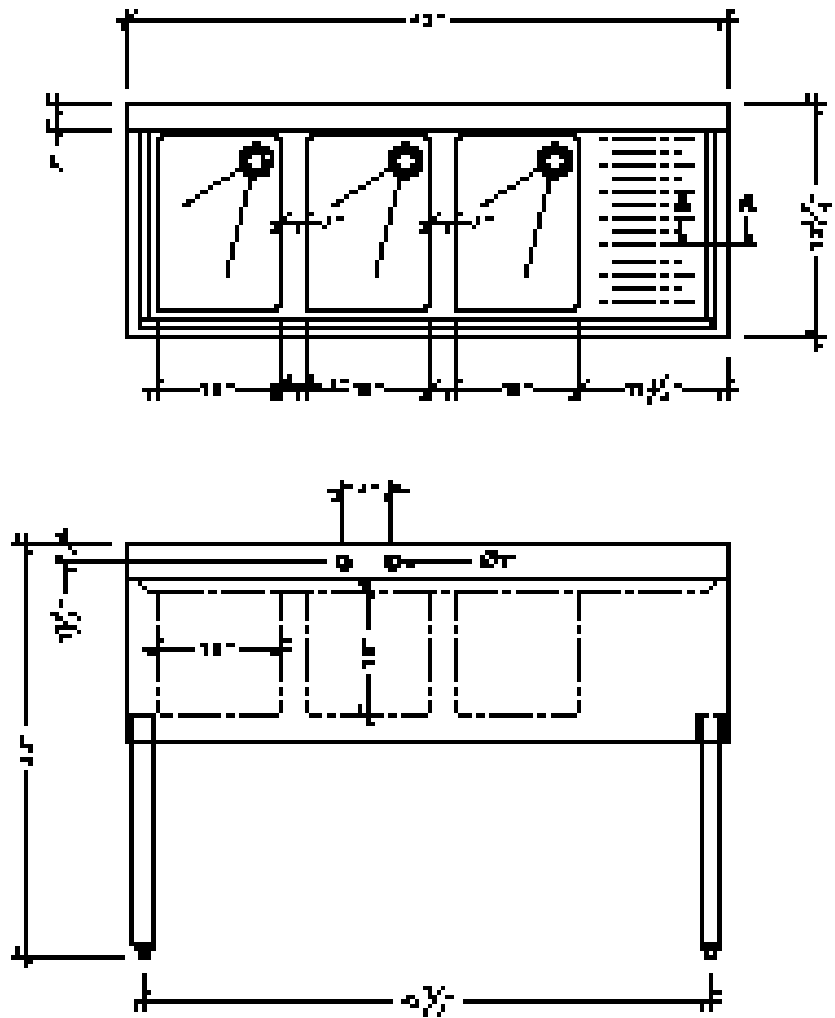
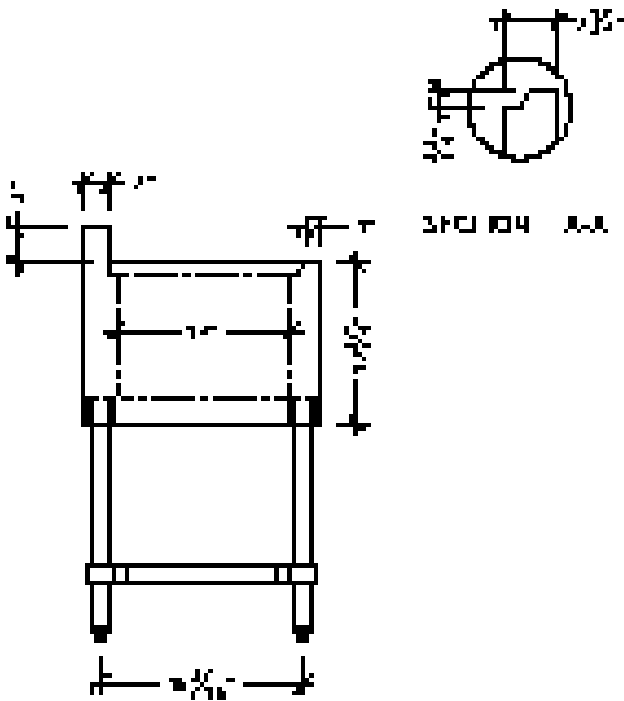

KRATOS

PROJECT NAME: _____

LOCATION: _____

ITEM #: _____ QTY: _____

MODEL: _____

29N-036

- 18 GA. 304 S/S TOP BOWL AND BACK #3 POL
- 20 GA. 304S/S APRON
- LEGS -16 GA. 1-5/8 DIA. GALV. TUBING
- 1-1/4 DIA. GALV. CROSS PIPE
- FEET - PLASTIC ADJUSTABLE BULLET FEET
- ALL SEAMS WELDED & POLISHED
- NO BURRS OR SHARP EDGES
- MEETS NSF STD. 2
- 3" BACKSPLASH
- 1-1/2" DRAIN BASKET INCLUDED

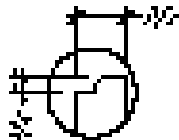
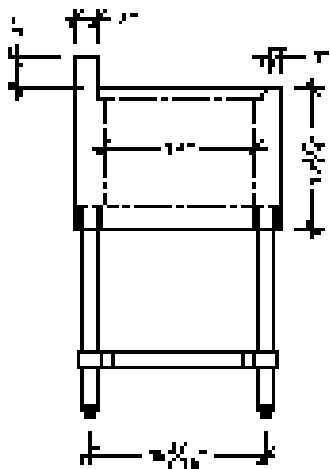

SECTION A-A

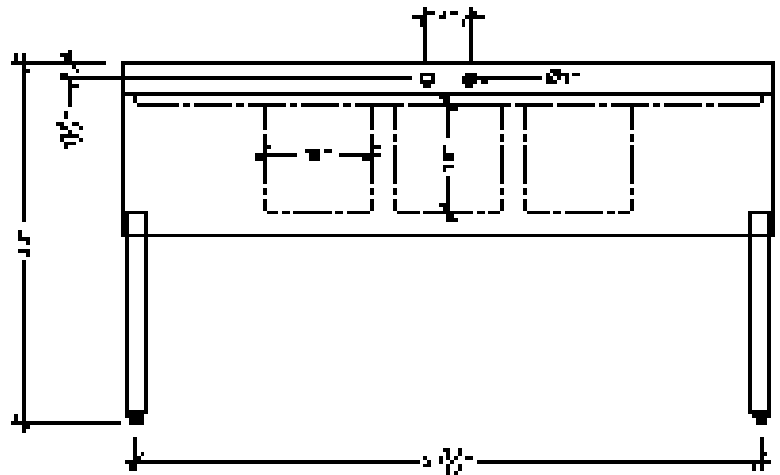
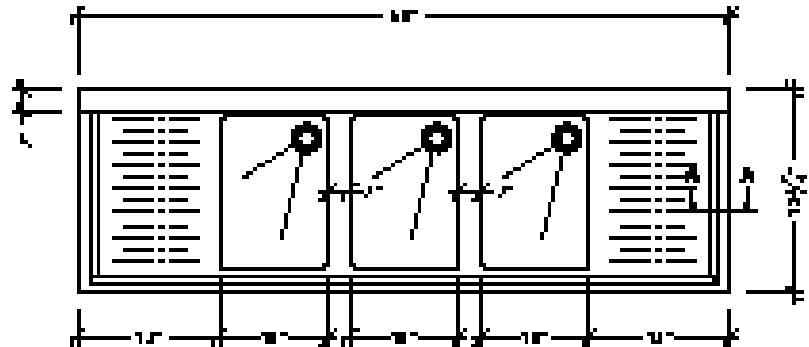

KRATOS

PROJECT NAME: _____

LOCATION: _____

ITEM #: _____ QTY: _____

MODEL: _____

29N-037

- 18 GA. 304 S/S TOP BOWL AND BACK #3 POL
- 20 GA. 304S/S APRON
- LEGS -16 GA. 1-5/8 DIA. GALV. TUBING
- 1-1/4 DIA. GALV. CROSS PIPE
- FEET - PLASTIC ADJUSTABLE BULLET FEET
- ALL SEAMS WELDED & POLISHED
- NO BURRS OR SHARP EDGES
- MEETS NSF STD. 2
- 3" BACKSPLASH
- 1-1/2" DRAIN BASKET INCLUDED

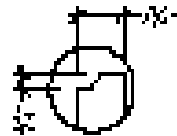
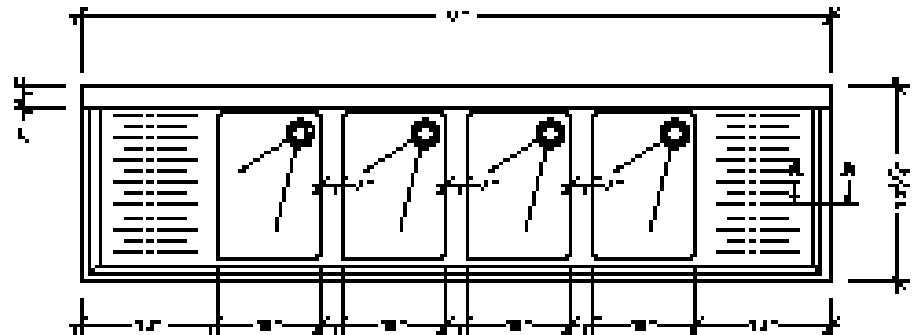

SECTION A-A

