

VITTLIIE

COMMERCIAL REFRIGERATION LINEUP

About Us

As a Food Service Establishment Owner and Professional, what do you lose sleep over: Equipment breakdowns or malfunction as that drives a wedge in the smooth operations of any restaurant, cafeteria, canteen, mom & pop store or supermarket . That' s where VITLIFE Commercial can play role of a trusted partner for you

VITLIFE Commercial is established by senior leaders in Industry and we have spent our entire life taking care of our customers. For us, your wish is our command. Professional product line that delivers when you need them most . Unrelenting durability and reliability, including Reach in Refrigerators & Freezers , pizza tables, chef bases , under counters , prep tables, Uprights, back bars , Merchandisers. You name it we have it

Our promise comes from who we are----- World class manufacturing facilities, state of the art equipment, leading product designers, laser focus on product innovation and quality, highly dependable logistics and order fulfillment processes which has led to strong global market presence and success in both mature and developing markets

All of this is possible through amazing teamwork where everyone is committed and contributes to your success. From shop floor operator to warehouse handler to our local technician and service partner , we leave no stone unturned in producing and bring to you best in class products which serve you wherever they are installed

We look forward to serving you in our best capacity as your success is our success

Hot pipe Anti-Condensation
Instead of Electric Wire Heater
More Security
Energy Saving



The Middle Mullion
Foamed Together With
Unit Body
No Gap More Strong

New Designed Air Duct
Air Flows Faster
Make the Temperature
More Balance



Add Air Deflector
Make the Temperature
More Balance





**Inside Wall is Flat
Beautiful & Easy to Clean**

Vertical Chiller & Freezer

**Add an Air Deflector
On the Inner Back
Make the Temperature
More Balance**



Vacuum Adsorption Liner

**Easy to Clean
adjustable shelves**



- Back bar
- Beverage cooler
- Vertical Chiller & Freezer



**BR/BF600V
Shelf Size can Fit
Basket and 2/1 GN Pan**



Reach-in Solid Door Refrigerator - Top-Mounted Series

- Stainless steel interior and exterior, Galvanized sheet back.
- Refrigeration system keeps food at safe temperature between 33°F and 41 °F (0.5 °C to 5°C).
- Self-Closing doors with 90 degree stay-open feature.
- Locks and keys included.
- Shelves: Adjustable heavy-duty epoxy coated shelves.
- Option of different handles & control panels available.
- Electronic control system makes it easy to adjust temperature set point and defrost frequency.
- Pre installed heavy-duty casters with brakes.
- New circulating air system, new designed air duct make the little temperature difference between top and bottom, better cooling efficiency
- EC fan motor, lower energy consumption, less noise, higher efficiency.



VRT27R



VRT54R

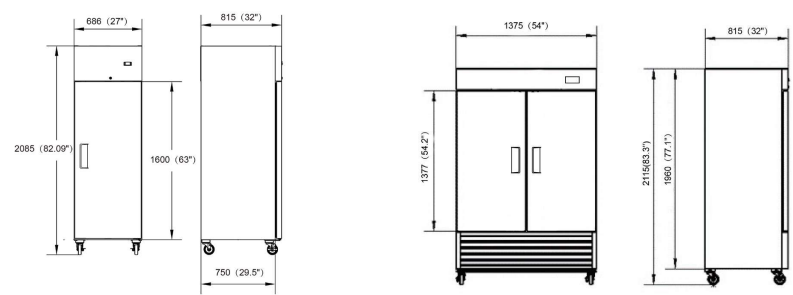

MODEL	DOORS	SHELVES	DIMENSION (WxDxH) Inches mm	CAPACITY cu.ft. liters	HP	AMPS	VOLTAGE	PLUG TYPE
VRT27R	1	3	27 *32 1/16*82 1/16 686*815*2085	594 21	1/5	1.7	115/60/1	5-15P
VRT54R	2	6	54 1/8*32 1/16*82 1/16 1375*815*2085	1302 46	1/4	2.1	115/60/1	5-15P



VITLIFE AMERICA LLC
 320 WINFIELD RD ,WARRENVILLE, IL 60555
 Tel: 800 604 5402
 Email : info@vitlifecommercial.com
 www.vitlifecommercial.com

Reach-in Solid Door Refrigerator - Bottom-Mounted Series

- Stainless steel interior and exterior, Galvanized sheet back.
- Refrigeration system keeps food at safe temperature between 33°F and 41 °F (0.5 °C to 5°C).
- Self-Closing doors with 90 degree stay-open feature.
- Locks and keys included.
- Shelves: Adjustable heavy-duty epoxy coated shelves.
- Option of different handles & control panels available.
- Electronic control system makes it easy to adjust temperature set point and defrost frequency.
- Pre installed heavy-duty casters with brakes.
- New circulating air system, new designed air duct make the little temperature difference between top and bottom, better cooling efficiency
- EC fan motor, lower energy consumption, less noise, higher efficiency.



VRB27R



VRB54R

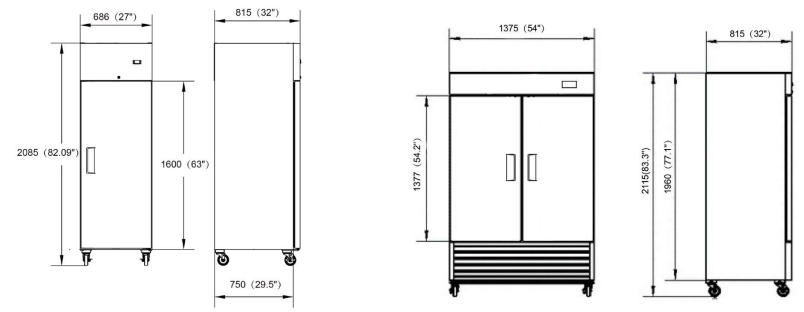

MODEL	DOORS	SHELVES	DIMENSION (WxDxH) Inches mm	CAPACITY cu.ft. liters	HP	AMPS	VOLTAGE	PLUG TYPE
VRB27R	1	3	27 *32 1/16*83 1/4 686*815*2115	594 21	1/5	1.7	115/60/1	5-15P
VRB54R	2	6	54 1/8*32 1/16*83 1/4 1375*815*2115	1302 46	1/4	2.1	115/60/1	5-15P



VITLIFE AMERICA LLC
 320 WINFIELD RD ,WARRENVILLE, IL 60555
 Tel: 800 604 5402
 Email : info@vitlifecommercial.com
 www.vitlifecommercial.com

Reach-in Solid Door Freezer - Top-Mounted Series

- Stainless steel interior and exterior, Galvanized sheet back.
- Refrigeration system keeps food at safe temperature between -8°F and 0 °F (-22 °C to -18 °C).
- Self-Closing doors with 90 degree stay-open feature.
- Shelves: Adjustable heavy-duty epoxy coated shelves.
- Option of different handles & control panels available.
- Hot pipe anti-condensation, not just in the door frame, but also in the middle vertical mullion, instead of the electric wire heater, more safe, more energy saving.
- Electronic control system makes it easy to adjust temperature set point and defrost frequency.
- Pre installed heavy-duty casters with brakes.
- New circulating air system, new designed air duct make the little temperature difference between top and bottom, better cooling efficiency
- EC fan motor, lower energy consumption, less noise, higher efficiency.
- Locks and keys included.
- Self-Closing doors with 90 degree stay-open feature.



VRT27F



VRT54F

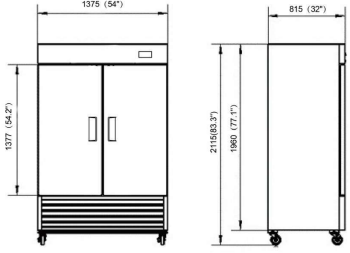
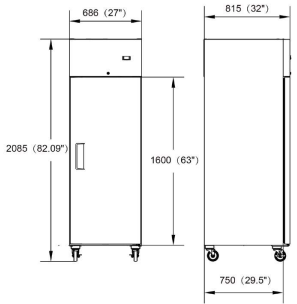

MODEL	DOORS	SHELVES	DIMENSION(WxDxH) inches mm	CAPACITY cu.ft. liters	HP	AMPS	VOLTAGE	PLUG TYPE
VRT27F	1	3	27 *32 1/16*82 1/16 686*815*2085	594 21	1/3	2.9	115/60/1	5-15P
VRT54F	2	6	54 1/8*32 1/16*82 1/16 1375*815*2085	1302 46	1/2	5	115/60/1	5-15P



VITLIFE AMERICA LLC
 320 WINFIELD RD ,WARRENVILLE, IL 60555
 Tel: 800 604 5402
 Email : info@vitlifecommercial.com
 www.vitlifecommercial.com

Reach-in Solid Door Freezer - Bottom-Mounted Series

- Stainless steel interior and exterior, Galvanized sheet back.
- Refrigeration system keeps food at safe temperature between -8°F and 0 °F (-22 °C to -18 °C).
- Self-Closing doors with 90 degree stay-open feature.
- Shelves: Adjustable heavy-duty epoxy coated shelves.
- Option of different handles & control panels available.
- Hot pipe anti-condensation, not just in the door frame, but also in the middle vertical mullion, instead of the electric wire heater, more safe, more energy saving.
- Electronic control system makes it easy to adjust temperature set point and defrost frequency.
- Pre installed heavy-duty casters with brakes.
- New circulating air system, new designed air duct make the little temperature difference between top and bottom, better cooling efficiency
- EC fan motor, lower energy consumption, less noise, higher efficiency.
- Locks and keys included.
- Self-Closing doors with 90 degree stay-open feature.



VRB27F



VRB54F

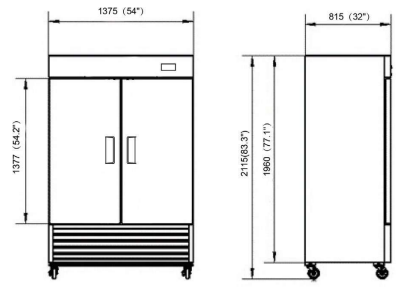
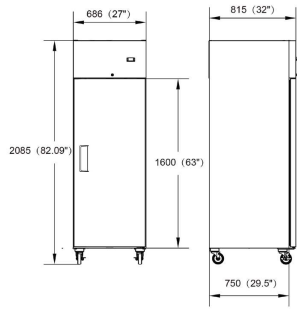

MODEL	DOORS	SHELVES	DIMENSION(WxDxH) inches mm	CAPACITY cu.ft. liters	HP	AMPS	VOLTAGE	PLUG TYPE
VRB27F	1	3	27 *32 1/16*83 1/4 686*815*2115	594 21	1/3	2.9	115/60/1	5-15P
VRB54F	2	6	54 1/8*32 1/16*83 1/4 1375*815*2115	1302 46	1/2	5	115/60/1	5-15P



VITLIFE AMERICA LLC
 320 WINFIELD RD ,WARRENVILLE, IL 60555
 Tel: 800 604 5402
 Email : info@vitlifecommercial.com
 www.vitlifecommercial.com

Reach-in Glass Door Refrigerator - Bottom-Mounted Series

- Stainless steel interior and exterior, Galvanized sheet back.
- Refrigeration system keeps food at safe temperature between 33°F and 41°F (0.5 °C to 5°C).
- Self-Closing doors with 90 degree stay-open feature.
- Shelves: Adjustable heavy-duty epoxy coated shelves.
- Door with 2 layers' tempered glass.
- New circulating air system, new designed air duct make the little temperature difference between top and bottom, better cooling efficiency
- Electronic control system makes it easy to adjust temperature set point and defrost frequency.
- Pre installed heavy-duty casters with brakes.
- EC fan motor, lower energy consumption, less noise, higher efficiency.
- Locks and keys included.
- Self-Closing doors with 90 degree stay-open feature.



VRB27RG



VRB54RG

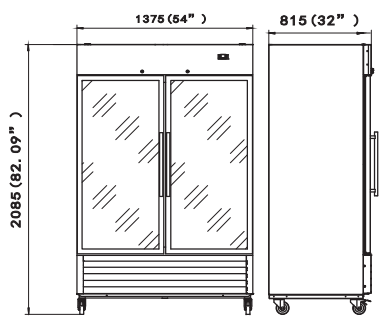
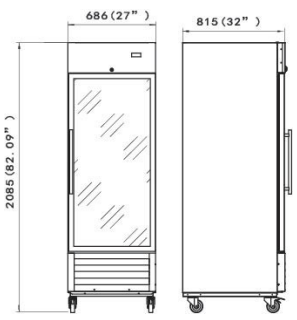

MODEL	DOORS	SHELVES	DIMENSION(WxDxH) inches mm	CAPACITY cu.ft. liters	HP	AMPS	VOLTAGE	PLUG TYPE
VRB27RG	1	3	27 *32 1/16*83 1/4 686*815*2115	594 21	1/5	2	115/60/1	5-15P
VRB54RG	2	6	54 1/8*32 1/16*83 1/4 1375*815*2115	1302 46	1/4	2.5	115/60/1	5-15P



VITLIFE AMERICA LLC
 320 WINFIELD RD ,WARRENVILLE, IL 60555
 Tel: 800 604 5402
 Email : info@vitlifecommercial.com
 www.vitlifecommercial.com

Reach-in Glass Door Freezer- Bottom-Mounted Series

- Stainless steel interior and exterior, Galvanized sheet back.
- Refrigeration system keeps food at safe temperature between -8°F and 0 °F (-22 °C to -18 °C).
- Self-Closing doors with 90 degree stay-open feature.
- Shelves: Adjustable heavy-duty epoxy coated shelves.
- 3 layers' tempered glass door with heater.
- New circulating air system, new designed air duct make the little temperature difference between top and bottom, better cooling efficiency
- Electronic control system makes it easy to adjust temperature set point and defrost frequency.
- Pre installed heavy-duty casters with brakes.
- EC fan motor, lower energy consumption, less noise, higher efficiency.
- Locks and keys included.
- Self-Closing doors with 90 degree stay-open feature.



VRB27FG



VRB54FG

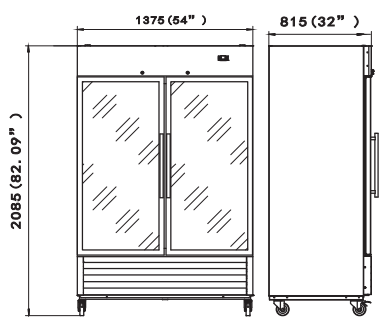
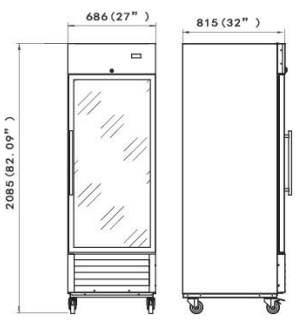

MODEL	DOORS	SHELVES	DIMENSION(WxDxH) inches mm	CAPACITY cu.ft. liters	HP	AMPS	VOLTAGE	PLUG TYPE
VRB27FG	1	3	27 *32 1/16*83 1/4 686*815*2115	594 21	1/3	3.2	115/60/1	5-15P
VRB54FG	2	6	54 1/8*32 1/16*83 1/4 1375*815*2115	1302 46	1/2	5.3	115/60/1	5-15P



VITLIFE AMERICA LLC
 320 WINFIELD RD ,WARRENVILLE, IL 60555
 Tel: 800 604 5402
 Email : info@vitlifecommercial.com
 www.vitlifecommercial.com

Under Counter Refrigerator - VUC Series

- Stainless steel interior and exterior, Galvanized sheet back.
- Refrigeration system keeps food at safe temperature between 33°F and 41°F (0.5 °C to 5°C).
- Self-Closing doors with 90 degree stay-open feature.
- Evaporation fan stop working when door is open, energy saving.
- Shelves: Adjustable heavy-duty epoxy coated shelves.
- Electronic control system makes it easy to adjust temperature set point and defrost frequency.
- Pre installed heavy-duty casters with brakes.
- EC fan motor, lower energy consumption, less noise, higher efficiency.
- Option of Backsplashes available.
- Option of different handles .



MODEL	DOORS	SHELVES	DIMENSION(WxDxH) inches mm	CAPACITY cu.ft. liters	HP	AMPS	VOLTAGE	PLUG TYPE
VUC29R	1	1	29*30*35 9/16 732*762*903	7.3 207	1/5	1.7	115/60/1	5-15P
VUC48R	2	2	48 1/4*30*35 9/16 1225*762*903	13.1 373	1/5	1.7	115/60/1	5-15P
VUC60R	2	2	60 1/4*30*35 9/16 1530*762*903	17 482	1/4	2.1	115/60/1	5-15P
VUC72R	3	3	72 11/16*30*35 9/16 1846*762*903	20.5 583	1/4	2.1	115/60/1	5-15P



VITLIFE AMERICA LLC
320 WINFIELD RD ,WARRENVILLE, IL 60555
Tel: 800 604 5402
Email : info@vitlifecommercial.com
www.vitlifecommercial.com

Under Counter Freezer - VUC Series

- Stainless steel interior and exterior, Galvanized sheet back.
- Refrigeration system keeps food at safe temperature between -8°F and 0 °F (-22 °C to -18 °C).
- Self-Closing doors with 90 degree stay-open feature.
- Evaporation fan stop working when door is open, energy saving.
- Shelves: Adjustable heavy-duty epoxy coated shelves.
- Option of different handles .
- Pre installed heavy-duty casters with brakes.
- Hot pipe anti-condensation, not just in the door frame, but also in the middle vertical mullion, instead of the electric wire heater, more safe, more energy saving.
- EC fan motor, lower energy consumption, less noise, higher efficiency.
- Option of Backsplashes available.
- Electronic control system makes it easy to adjust temperature set point and defrost frequency.



MODEL	DOORS	SHELVES	DIMENSION(WxDxH) inches mm	CAPACITY cu.ft. liters	HP	AMPS	VOLTAGE	PLUG TYPE
VUC29F	1	1	29*30*35 9/16 732*762*903	7.3 207	1/5	1.7	115/60/1	5-15P
VUC48F	2	2	48 1/4*30*35 9/16 1225*762*903	13.1 373	1/3	2.9	115/60/1	5-15P
VUC60F	2	2	60 1/4*30*35 9/16 1530*762*903	17 482	1/3	2.9	115/60/1	5-15P
VUC72F	3	3	72 11/16*30*35 9/16 1846*762*903	20.5 583	1/2	4.1	115/60/1	5-15P



VITLIFE AMERICA LLC
320 WINFIELD RD ,WARRENVILLE, IL 60555
Tel: 800 604 5402
Email : info@vitlifecommercial.com
www.vitlifecommercial.com

Under Counter Refrigerator With Backsplash Series

- Stainless steel interior and exterior, Galvanized sheet back.
- Refrigeration system keeps food at safe temperature between 33°F and 41°F (0.5 °C to 5°C).
- Self-Closing doors with 90 degree stay-open feature.
- Evaporation fan stop working when door is open, energy saving.
- Shelves: Adjustable heavy-duty epoxy coated shelves.
- Electronic control system makes it easy to adjust temperature set point and defrost frequency.
- Pre installed heavy-duty casters with brakes.
- EC fan motor, lower energy consumption, less noise, higher efficiency.
- Option of Backsplashes available.
- Option of different handles .



MODEL	DOORS	SHELVES	DIMENSION(WxDxH) inches mm	CAPACITY cu.ft. liters	HP	AMPS	VOLTAGE	PLUG TYPE
VUC29RW	1	1	29*30*39 9/16 732*762*992	7.3 207	1/5	1.7	115/60/1	5-15P
VUC48RW	2	2	48 1/4*30*39 9/16 1225*762*992	13.1 373	1/5	1.7	115/60/1	5-15P
VUC60RW	2	2	60 1/4*30*39 9/16 1530*762*992	17 482	1/4	2.1	115/60/1	5-15P
VUC72RW	3	3	72 11/16*30*39 9/16 1846*762*992	20.5 583	1/4	2.1	115/60/1	5-15P



VITLIFE AMERICA LLC
320 WINFIELD RD ,WARRENVILLE, IL 60555
Tel: 800 604 5402
Email : info@vitlifecommercial.com
www.vitlifecommercial.com

Under Counter Freezer With Backsplash Series

- Stainless steel interior and exterior, Galvanized sheet back.
- Refrigeration system keeps food at safe temperature between -8°F and 0 °F (-22 °C to -18 °C).
- Self-Closing doors with 90 degree stay-open feature.
- Evaporation fan stop working when door is open, energy saving.
- Shelves: Adjustable heavy-duty epoxy coated shelves.
- Option of different handles .
- Pre installed heavy-duty casters with brakes.
- Hot pipe anti-condensation, not just in the door frame, but also in the middle vertical mullion, instead of the electric wire heater, more safe, more energy saving.
- EC fan motor, lower energy consumption, less noise, higher efficiency.
- Option of Backsplashes available.
- Electronic control system makes it easy to adjust temperature set point and defrost frequency.

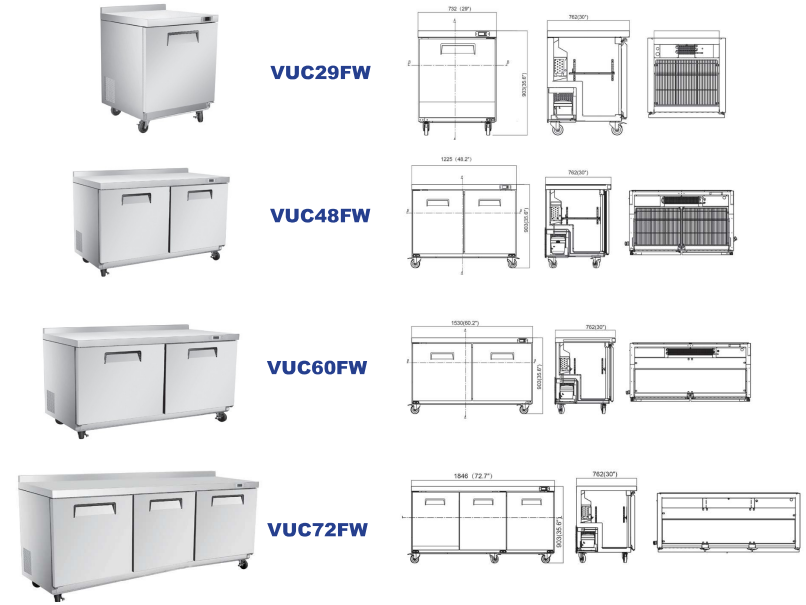

MODEL	DOORS	SHELVES	DIMENSION(WxDxH) inches mm	CAPACITY cu.ft. liters	HP	AMPS	VOLTAGE	PLUG TYPE
VUC29FW	1	1	29*30*39 9/16 732*762*992	7.3 207	1/5	1.7	115/60/1	5-15P
VUC48FW	2	2	48 1/4*30*39 9/16 1225*762*992	13.1 373	1/3	2.9	115/60/1	5-15P
VUC60FW	2	2	60 1/4*30*39 9/16 1530*762*992	17 482	1/3	2.9	115/60/1	5-15P
VUC72FW	3	3	72 11/16*30*39 9/16 1846*762*992	20.5 583	1/2	4.1	115/60/1	5-15P



VITLIFE AMERICA LLC
320 WINFIELD RD ,WARRENVILLE, IL 60555
Tel: 800 604 5402
Email : info@vitlifecommercial.com
www.vitlifecommercial.com

Sandwich/Salad Prep Table

- Stainless steel interior and exterior, Galvanized sheet back.
- Refrigeration system keeps food at safe temperature between 33°F and 41°F (0.5 °C to 5°C).
- Self-Closing doors with 90 degree stay-open feature.
- Cutting boards and pans available.
- Shelves: Adjustable heavy-duty epoxy coated shelves.
- Option of different handles .
- Electronic control system makes it easy to adjust temperature set point and defrost frequency.
- Pre installed heavy-duty casters with brakes.
- Evaporation fan stop working when door is open, energy saving.
- EC fan motor, lower energy consumption, less noise, higher efficiency.



MODEL	DOORS	SHELVES	DIMENSION(WxDxH) inches mm	CAPACITY cu. ft. liters	HP	AMPS	VOLTAGE	PLUG TYPE
VSP29	1	1	29*30*42 5/8 732*762*1082	7.6 215	1/5	1.7	115/60/1	5-15P
VSP48	2	2	48 1/4*30*42 5/8 1225*762*1082	13.8 390	1/5	1.7	115/60/1	5-15P
VSP60	2	2	60 1/4*30*42 5/8 1530*762*1082	17.8 505	1/4	2.1	115/60/1	5-15P
VSP72	3	3	72 11/16*30*42 5/8 1846*762*1082	21.2 601	1/4	2.1	115/60/1	5-15P



VITLIFE AMERICA LLC
320 WINFIELD RD ,WARRENVILLE, IL 60555
Tel: 800 604 5402
Email : info@vitlifecommercial.com
www.vitlifecommercial.com

Mega top Sandwich/Salad Prep Table

- Stainless steel interior and exterior, Galvanized sheet back.
- Refrigeration system keeps food at safe temperature between 33°F and 41°F (0.5 °C to 5°C).
- Self-Closing doors with 90 degree stay-open feature.
- Cutting boards and pans available.
- Shelves: Adjustable heavy-duty epoxy coated shelves.
- Option of different handles .
- Electronic control system makes it easy to adjust temperature set point and defrost frequency.
- Pre installed heavy-duty casters with brakes.
- Evaporation fan stop working when door is open, energy saving.
- EC fan motor, lower energy consumption, less noise, higher efficiency.



MODEL	DOORS	SHELVES	DIMENSION(WxDxH) inches mm	CAPACITY cu. ft. liters	HP	AMPS	VOLTAGE	PLUG TYPE
VSP29(M)	1	1	29*30*42 5/8 732*762*1082	7.6 215	1/5	1.7	115/60/1	5-15P
VSP48(M)	2	2	48 1/4*30*42 5/8 1225*762*1082	13.8 390	1/5	1.7	115/60/1	5-15P
VSP60(M)	2	2	60 1/4*30*42 5/8 1530*762*1082	17.8 505	1/4	2.1	115/60/1	5-15P
VSP72(M)	3	3	72 11/16*30*42 5/8 1846*762*1082	21.2 601	1/4	2.1	115/60/1	5-15P



VITLIFE AMERICA LLC
320 WINFIELD RD ,WARRENVILLE, IL 60555
Tel: 800 604 5402
Email : info@vitlifecommercial.com
www.vitlifecommercial.com

Pizza Prep Table

- Stainless steel interior and exterior, Galvanized sheet back.
- Refrigeration system keeps food at safe temperature between 33°F and 41°F (0.5 °C to 5°C).
- Self-Closing doors with 90 degree stay-open feature.
- Cutting boards and pans available.
- Shelves: Adjustable heavy-duty epoxy coated shelves.
- Option of different handles .
- Electronic control system makes it easy to adjust temperature set point and defrost frequency.
- Pre installed heavy-duty casters with brakes.
- Evaporation fan stop working when door is open, energy saving.
- EC fan motor, lower energy consumption, less noise, higher efficiency.

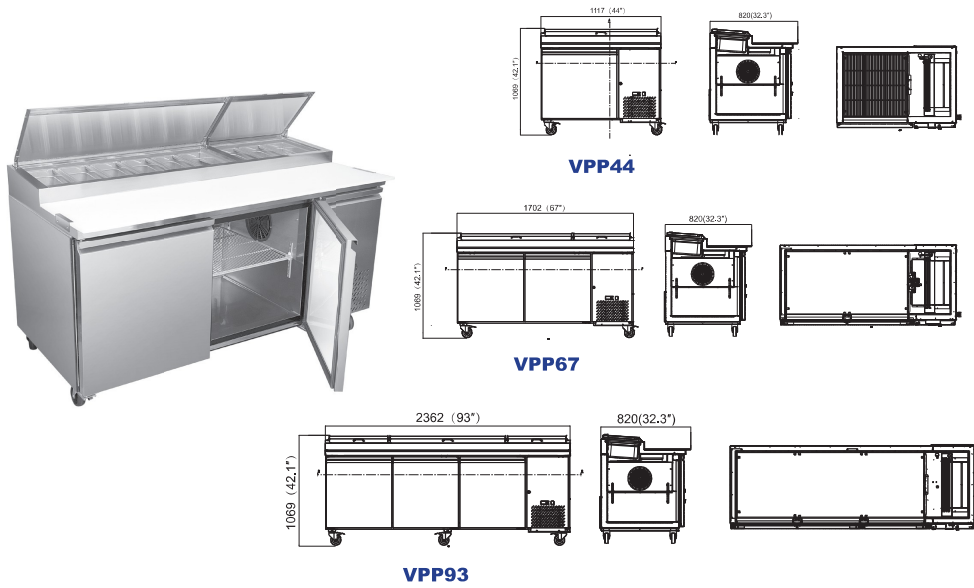

MODEL	DOORS	SHELVES	DIMENSION(WxDxH) Inches mm	CAPACITY cu.ft. liters	HP	AMPS	VOLTAGE	PLUG TYPE
VPP44	1	1	44*32 5/16*42 1/16 1142*880*1136	10.9 310	1/5	1.7	115/60/1	5-15P
VPP67	2	2	67 *32 5/16*42 1/16 1727*880*1136	20.9 592	1/3	2.9	115/60/1	5-15P
VPP93	3	3	93*32 5/16*42 1/16 2387*880*1136	30.8 872	1/2	4.1	115/60/1	5-15P



VITLIFE AMERICA LLC
 320 WINFIELD RD ,WARRENVILLE, IL 60555
 Tel: 800 604 5402
 Email : info@vitlifecommercial.com
 www.vitlifecommercial.com

Chef Base Refrigerator

- Stainless steel interior and exterior, Galvanized sheet back.
- Stainless steel top equipped with a marine edge enables the unit's top to contain drips and spills for easy cleanup.
- Refrigeration system keeps food at safe temperatures, between 33°F and 41°F (0.5°C to 5°C).
- Preinstalled heavy-duty casters with brakes.
- Electronic control system makes it easy to adjust temperature set point and defrost frequency.
- Evaporation fan stop working when door is open, energy saving.
- Heavy-duty pull handles.

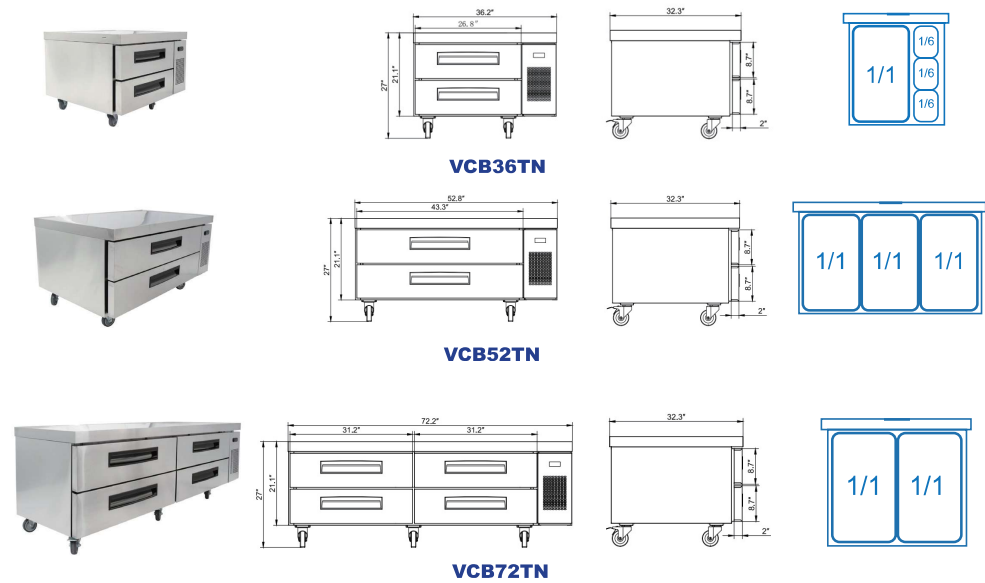

MODEL	DOORS	GN PANS FOR EVERY DRAWER	DIMENSION(WxDxH) Inches mm	CAPACITY cu.ft. liters	HP	AMPS	VOLTAGE	PLUG TYPE
VCB36TN	2	3*1/6+1*1/1	44*32 5/16*42 1/16 1142*880*1136	10.9 310	1/5	2.6	115/60/1	5-15P
VCB52TN	2	3*1/1	67 *32 5/16*42 1/16 1727*880*1136	20.9 592	1/5	2.7	115/60/1	5-15P
VCB72TN	4	2*1/1	93*32 5/16*42 1/16 2387*880*1136	30.8 872	1/5	3.1	115/60/1	5-15P



VITLIFE AMERICA LLC
 320 WINFIELD RD ,WARRENVILLE, IL 60555
 Tel: 800 604 5402
 Email : info@vitlifecommercial.com
 www.vitlifecommercial.com

Refrigerated Topping Unit

- Interior and exterior stainless steel material for high level product.
- High quality famous compressor.
- Electronic control system makes it easy to adjust temperature set point and defrost frequency.
- Accept GN1/6 pans range.
- CFC free foaming.
- Adjustable feet.
- Refrigeration system keeps food at safe temperature between 32°F and 50 °F (0 °C to 10°C).



VRTR4

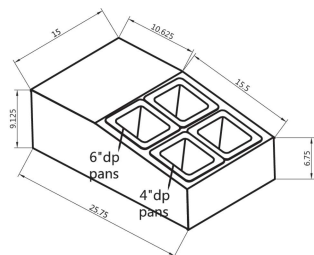

VRTR8

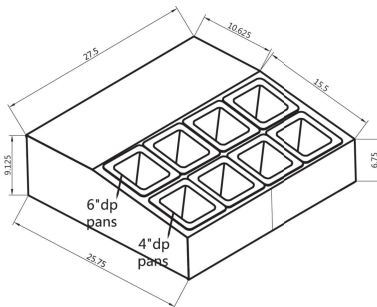

MODEL	GN PANS	DIMENSION(WxDxH) inches mm	HP	AMPS	VOLTAGE	PLUG TYPE
VRTR4	GN1/6*4	14 15/16*25 13/16*9 5/16 379*656*236	1/5	1.4	115/60/1	5-15P
VRTR8	GN1/6*8	27 1/2*25 13/16*9 5/16 699*656*236	1/5	1.4	115/60/1	5-15P



VITLIFE AMERICA LLC
320 WINFIELD RD ,WARRENVILLE, IL 60555
Tel: 800 604 5402
Email : info@vitlifecommercial.com
www.vitlifecommercial.com

VRX

- Interior and exterior stainless steel material for high level product.
- High quality famous compressor.
- Electronic control system makes it easy to adjust temperature set point and defrost frequency.
- CFC free foaming.
- Adjustable feet.
- Refrigeration system keeps food at safe temperature between 33°F and 41 °F (0.5 °C to 5°C).
- Option of LED lighting.



VVRX with glass top



VVRX with stainless steel lid

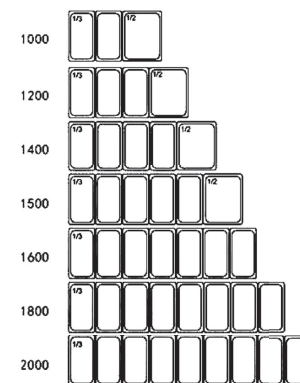

MODEL	GN PANS	DIMENSION(WxDxH) inches mm	HP	AMPS	VOLTAGE	PLUG TYPE
VVRX1200/380	GN1/3*3+ GN1/2*1	47 1/4*15 1/2*17 1/8 1200*395*435	1/5	1.4	115/60/1	5-15P
VVRX1500/380	GN1/3*5+ GN1/2*1	59*15 1/2*17 1/8 1500*395*435	1/5	1.4	115/60/1	5-15P
VVRX2000/380	GN1/3*9	78 3/4*15 1/2*17 1/8 2000*395*435	1/5	1.4	115/60/1	5-15P



VITLIFE AMERICA LLC
320 WINFIELD RD ,WARRENVILLE, IL 60555
Tel: 800 604 5402
Email : info@vitlifecommercial.com
www.vitlifecommercial.com

Upright Ventilated Chiller

- Exterior: Coated steel. Black or white finish available.
Interior: Integrated Vacuum adsorption HIPS liner, easy to clean.
- Refrigeration system keeps food at safe temperature between 33°F and 41°F (0.5°C to 5°C).
- Shelves: Adjustable heavy-duty epoxy coated shelves.
- Option of external or full length handles .
- Locks and keys included.
- Electronic control system makes it easy to adjust temperature set point and defrost frequency.
- Leveling feet or casters are available.
- New circulating air system, new designed air duct make the little temperature difference between top and bottom, better cooling efficiency
- The door can be reversed left and right.
- Option of top LED lighting



MODEL	SHELVES	DIMENSION(WxDxH) inches mm	CAPACITY cu.ft. liters	HP	AMPS	VOLTAGE	PLUG TYPE
VBR200VW	2	23 3/8"25 3/4"34 5/8 595x655x880	4 115	1/5	1.5	115/60/1	5-15P
VBR400VW	4	23 3/8"26 1/8"74 1/8 595x662x1882	10.4 293	1/5	1.5	115/60/1	5-15P
VBR600VW	4	30 1/2"30"74 1/8 775x762x1882	18 510	1/4	2.0	115/60/1	5-15P



VITLIFE AMERICA LLC
320 WINFIELD RD ,WARRENVILLE, IL 60555
Tel: 800 604 5402
Email : info@vitlifecommercial.com
www.vitlifecommercial.com

Upright Ventilated Freezer

- Exterior: Coated steel. Black or white finish available.
Interior: Integrated Vacuum adsorption HIPS liner, easy to clean.
- Refrigeration system keeps food at safe temperature between -8°F and 0 °F (-22 °C to -18 °C).
- Shelves: Adjustable heavy-duty epoxy coated shelves.
- Option of external or full length handles .
- Locks and keys included.
- Electronic control system makes it easy to adjust temperature set point and defrost frequency.
- Leveling feet or casters are available.
- New circulating air system, new designed air duct make the little temperature difference between top and bottom, better cooling efficiency
- The door can be reversed left and right.
- Option of top LED lighting



MODEL	SHELVES	DIMENSION(WxDxH) inches mm	CAPACITY cu.ft. liters	HP	AMPS	VOLTAGE	PLUG TYPE
VBF200VW	2	23 3/8"25 3/4"34 5/8 595x655x880	4 115	1/5	1.9	115/60/1	5-15P
VBF400VW	4	23 3/8"26 1/8"74 1/8 595x662x1882	10.4 293	1/3	3.3	115/60/1	5-15P
VBF600VW	4	30 1/2"30"74 1/8 775x762x1882	18 510	1/2	5.5	115/60/1	5-15P



VITLIFE AMERICA LLC
320 WINFIELD RD ,WARRENVILLE, IL 60555
Tel: 800 604 5402
Email : info@vitlifecommercial.com
www.vitlifecommercial.com

Upright Ventilated Chiller-Glass door series

- Exterior: Coated steel. Black or white finish available.
Interior: Integrated Vacuum adsorption HIPS liner, easy to clean.
- Refrigeration system keeps food at safe temperature between 33°F and 41 °F (0.5°C to 5°C).
- Shelves: Adjustable heavy-duty epoxy coated shelves.
- Option of external or full length handles .
- Locks and keys included.
- Electronic control system makes it easy to adjust temperature set point and defrost frequency.
- Leveling feet or casters are available.
- New circulating air system, new designed air duct make the little temperature difference between top and bottom, better cooling efficiency.
- Top LED lighting.
- Aluminum alloy door frame and 2 layers' tempered glass.



MODEL	SHELVES	DIMENSION(WxDxH) inches mm	CAPACITY cu.ft. liters	HP	AMPS	VOLTAGE	PLUG TYPE
VBR200VGW	2	23 3/8" 25 3/4" 34 5/8 595x655x880	4 115	1/6	1.5	115/60/1	5-15P
VBR400VGW	4	23 3/8" 26 1/8" 74 1/8 595x662x1882	10.4 293	1/6	1.5	115/60/1	5-15P
VBR600VGW	4	30 1/2" 30" 74 1/8 775x762x1882	18 510	1/5	2.0	115/60/1	5-15P

Upright Ventilated Chiller-Glass door series

- Exterior: Coated steel. Black or white finish available.
Interior: Integrated Vacuum adsorption HIPS liner, easy to clean.
- Refrigeration system keeps food at safe temperature between -8°F and 0 °F (-22 °C to -18 °C).
- Shelves: Adjustable heavy-duty epoxy coated shelves.
- Option of external or full length handles .
- Locks and keys included.
- Electronic control system makes it easy to adjust temperature set point and defrost frequency.
- Leveling feet or casters are available.
- New circulating air system, new designed air duct make the little temperature difference between top and bottom, better cooling efficiency.
- Top LED lighting.
- Aluminum alloy door frame and 3 layers' tempered glass with heater.

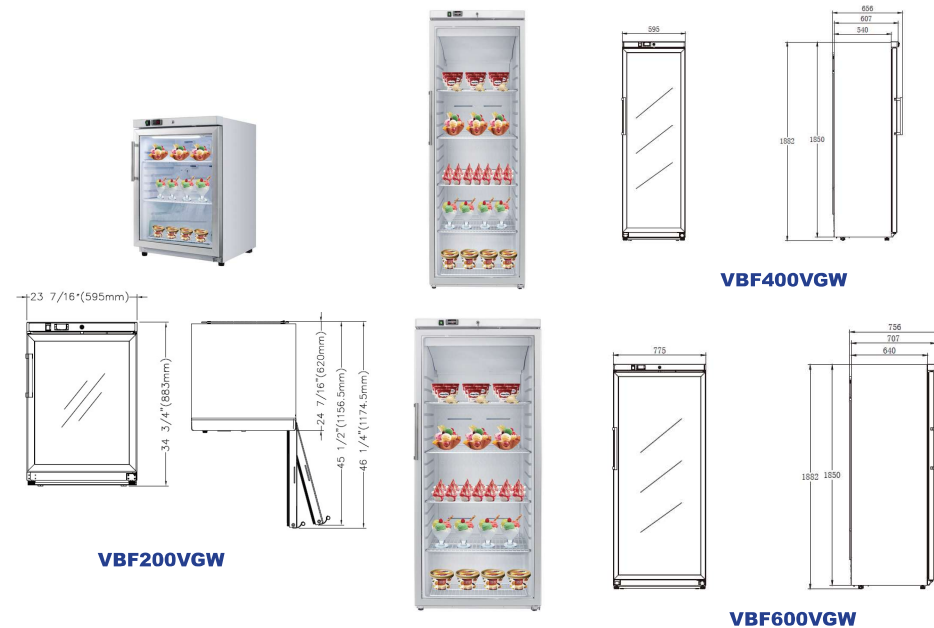

MODEL	SHELVES	DIMENSION(WxDxH) inches mm	CAPACITY cu.ft. liters	HP	AMPS	VOLTAGE	PLUG TYPE
VBF200VGW	2	23 3/8" 25 3/4" 34 5/8 595x655x880	4 115	1/5	2.3	115/60/1	5-15P
VBF400VGW	4	23 3/8" 26 1/8" 74 1/8 595x662x1882	10.4 293	1/3	3.3	115/60/1	5-15P
VBF600VGW	4	30 1/2" 30" 74 1/8 775x762x1882	18 510	1/2	5.7	115/60/1	5-15P



VITLIFE AMERICA LLC
320 WINFIELD RD ,WARRENVILLE, IL 60555
Tel: 800 604 5402
Email : info@vitlifecommercial.com
www.vitlifecommercial.com



VITLIFE AMERICA LLC
320 WINFIELD RD ,WARRENVILLE, IL 60555
Tel: 800 604 5402
Email : info@vitlifecommercial.com
www.vitlifecommercial.com

Back Bar cooler-Swing doors series

- Exterior: Coated steel.
Interior: Integrated Vacuum adsorption HIPS liner, easy to clean.
- Refrigeration system keeps food at safe temperature between 36°F and 50 °F (2°C to 10°C).
- Shelves: Adjustable heavy-duty epoxy coated shelves.

- Electronic control system makes it easy to adjust temperature set point and defrost frequency.
- TOP LED lighting.
- Locks and keys included.

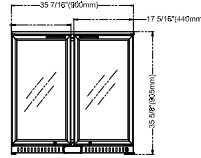

VBBD238H

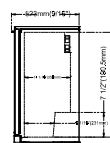
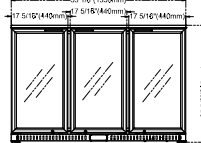
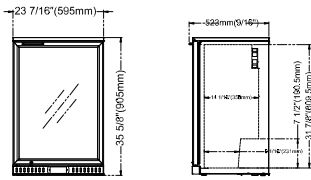

VBBT338H

VBBS138H

MODEL	DOORS	SHELVES	DIMENSION(WxDxH) inches mm	CAPACITY cu.ft. liters	HP	AMPS	VOLTAGE	PLUG TYPE
VBBS138H	1	2	23 5/8*20 1/2*35 3/8 600×520×900	4.7 134	1/5	0.9	115/60/1	5-15P
VBBD238H	2	4	35 3/8*20 1/2*35 3/8 900×520×900	7.5 212	1/5	1.4	115/60/1	5-15P
VBBT338H	3	6	53 1/8*20 1/2*35 3/8 1350×520×900	11.6 328	1/4+	2.1	115/60/1	5-15P



VITLIFE AMERICA LLC
320 WINFIELD RD ,WARRENVILLE, IL 60555
Tel: 800 604 5402
Email : info@vitlifecommercial.com
www.vitlifecommercial.com

Back Bar cooler-Sliding doors series

- Exterior: Coated steel.
Interior: Integrated Vacuum adsorption HIPS liner, easy to clean.
- Refrigeration system keeps food at safe temperature between 36°F and 50 °F (2°C to 10°C).
- Shelves: Adjustable heavy-duty epoxy coated shelves.
- Glass doors self-closing by gravity.

- Electronic control system makes it easy to adjust temperature set point and defrost frequency.
- Top LED lighting.
- Locks and keys included.

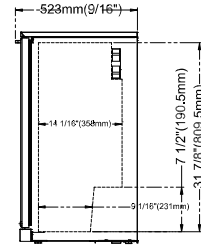
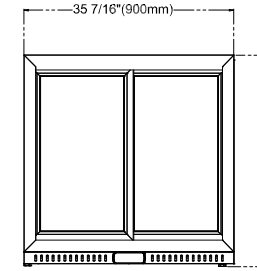

VBBD238S

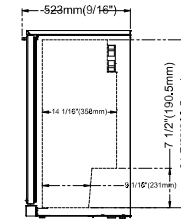
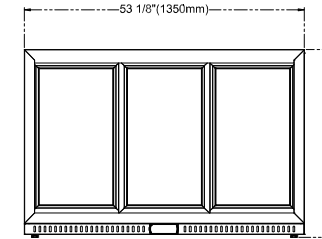

VBBT338S

MODEL	DOORS	SHELVES	DIMENSION(WxDxH) inches mm	CAPACITY cu.ft. liters	HP	AMPS	VOLTAGE	PLUG TYPE
VBBD238S	2	4	35 3/8*20 1/2*35 3/8 900×520×900	7.5 212	1/5	1.4	115/60/1	5-15P
VBBT338S	3	6	53 1/8*20 1/2*35 3/8 1350×520×900	11.6 328	1/4+	2.1	115/60/1	5-15P



VITLIFE AMERICA LLC
320 WINFIELD RD ,WARRENVILLE, IL 60555
Tel: 800 604 5402
Email : info@vitlifecommercial.com
www.vitlifecommercial.com

Merchandising Swing Glass Door Refrigerator

- Ventilated cooling system, auto defrost.
- Exterior: Coated steel.
Interior: Integrated Vacuum adsorption HIPS liner, easy to clean.
- Refrigeration system keeps food at safe temperature between 33°F and 41 °F (0.5°C to 5°C).
- Shelves: Adjustable heavy-duty epoxy coated shelves.
- Electronic control system makes it easy to adjust temperature set point and defrost frequency.
- LED lighting.
- C: with canopy T: without canopy

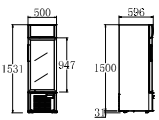

VSC188VCW

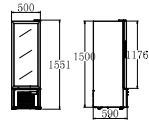

VSC198VTW

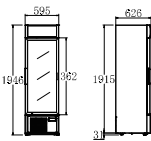

VSC388VCW

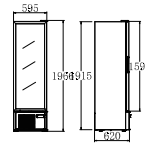

VSC398VTW

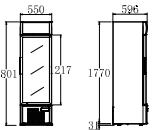

VSC288VCW

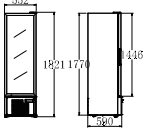

VSC298VTW

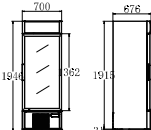

VSC488VCW

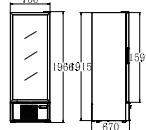

VSC498VTW

MODEL	DOORS	SHELVES	DIMENSION(WxDxH) inches mm	CAPACITY cu.ft. liters	HP	AMPS	VOLTAGE	PLUG TYPE
VSC188VCW	1	4	19 5/8*23 1/2*60 1/4 500*596*1531	6.4 181	1/5	2.2	115/60/1	5-15P
VSC198VTW	1	4	19 5/8*23 1/2*60 1/4 500*596*1531	6.6 188	1/5	2.2	115/60/1	5-15P
VSC288VCW	1	4	19 5/8*23 1/2*70 7/8 550*596*1801	8.8 249	1/5	2.3	115/60/1	5-15P
VSC298VTW	1	4	19 5/8*23 1/2*70 7/8 550*596*1801	9.1 258	1/5	2.3	115/60/1	5-15P
VSC388VCW	1	4	23 3/8*24 5/8*76 5/8 595*626*1946	12.3 348	1/5	2.4	115/60/1	5-15P
VSC398VTW	1	4	23 3/8*24 5/8*76 5/8 595*626*1946	12.6 356	1/5	2.4	115/60/1	5-15P
VSC488VCW	1	4	27 1/2*26 5/8*76 5/8 700*676*1946	16.5 468	1/5	2.6	115/60/1	5-15P
VSC498VTW	1	4	27 1/2*26 5/8*76 5/8 700*676*1946	16.9 478	1/5	2.6	115/60/1	5-15P



VITLIFE AMERICA LLC
320 WINFIELD RD ,WARRENVILLE, IL 60555
Tel: 800 604 5402
Email : info@vitlifecommercial.com
www.vitlifecommercial.com

Merchandising Swing Glass Door Refrigerator

- Ventilated cooling system, auto defrost.
- Exterior: Coated steel.
Interior: Integrated Vacuum adsorption HIPS liner, easy to clean.
- Refrigeration system keeps food at safe temperature between 33°F and 41 °F (0.5°C to 5°C).
- Shelves: Adjustable heavy-duty epoxy coated shelves.
- Electronic control system makes it easy to adjust temperature set point and defrost frequency.
- LED lighting.
- C: with canopy T: without canopy

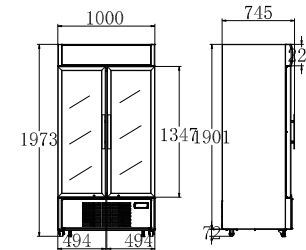

VSC788VCW

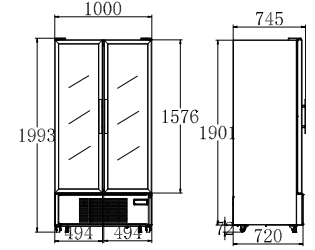

VSC798VTW

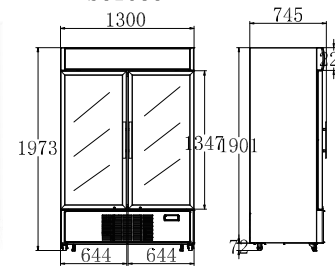

VSC1088VCW

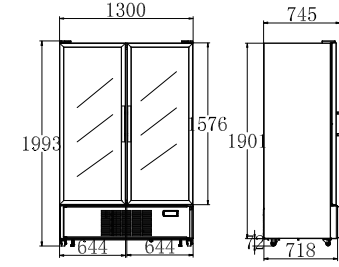

VSC1098VTW

MODEL	DOORS	SHELVES	DIMENSION(WxDxH) inches mm	CAPACITY cu.ft. liters	HP	AMPS	VOLTAGE	PLUG TYPE
VSC788VCW	2	8	39 3/8*29 3/8*77 5/8 1000*745*1973	26 736	1/4+	6	115/60/1	5-15P
VSC798VTW	2	8	39 3/8*29 3/8*77 5/8 1000*745*1973	26.5 751	1/4+	6	115/60/1	5-15P
VSC1088VCW	2	8	51 1/8*29 3/8*77 5/8 1300*745*1973	35.3 1001	1/4+	6	115/60/1	5-15P
VSC1098VTW	2	8	51 1/8*29 3/8*77 5/8 1300*745*1973	36 1020	1/4+	6	115/60/1	5-15P



VITLIFE AMERICA LLC
320 WINFIELD RD ,WARRENVILLE, IL 60555
Tel: 800 604 5402
Email : info@vitlifecommercial.com
www.vitlifecommercial.com

Merchandising Sliding Door Refrigerator

- Ventilated cooling system, auto defrost.
- Exterior: Coated steel.
Interior: Integrated Vacuum adsorption HIPS liner, easy to clean.
- Refrigeration system keeps food at safe temperature between 33°F and 41°F (0.5°C to 5°C).
- Shelves: Adjustable heavy-duty epoxy coated shelves.
- Electronic control system makes it easy to adjust temperature set point and defrost frequency.
- LED lighting.
- C: with canopy T: without canopy

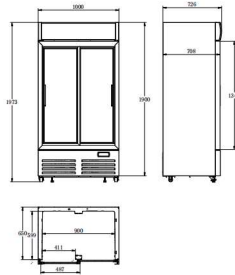

VSC788VCS

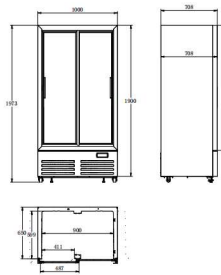

VSC798VTS

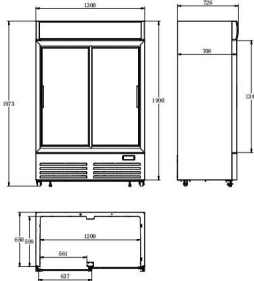

VSC1088VCS

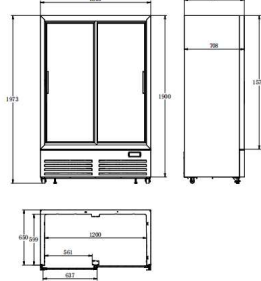

VSC1098VTS

MODEL	DOORS	SHELVES	DIMENSION(WxDxH) inches mm	CAPACITY cu.ft. liters	HP	AMPS	VOLTAGE	PLUG TYPE
VSC788VCS	2	8	39 3/8*29 3/8*77 5/8 1000×745×1973	26 736	1/4+	6	115/60/1	5-15P
VSC798VTS	2	8	39 3/8*29 3/8*77 5/8 1000×745×1973	26.5 751	1/4+	6	115/60/1	5-15P
VSC1088VCS	2	8	51 1/8*29 3/8*77 5/8 1300×745×1973	35.3 1001	1/4+	6	115/60/1	5-15P
VSC1098VTS	2	8	51 1/8*29 3/8*77 5/8 1300×745×1973	36 1020	1/4+	6	115/60/1	5-15P



VITLIFE AMERICA LLC
 320 WINFIELD RD ,WARRENVILLE, IL 60555
 Tel: 800 604 5402
 Email : info@vitlifecommercial.com
 www.vitlifecommercial.com

VITLIFE AMERICA LLC
 320 WINFIELD RD ,WARRENVILLE, IL 60555
 Tel: 800 604 5402
 Email : info@vitlifecommercial.com
 www.vitlifecommercial.com