



"WE MAKE THE KITCHEN BETTER!"

ATOSA USA, INC.

Toll Free: 855-855-0399 Email: info@atosausa.com

www.atosa.com | www.atosausa.com

California, Colorado, Florida, Georgia, Illinois,
New Jersey, Ohio, Texas, Washington

Walk-in Coolers

MODELS:

AWC0608-TF-IL/IR / AWC0808-TF-IL/IR
AWC0810-TF-IL/IR / AWC1010-TF-IL/IR
AWC1012-TF-IL/IR

Standard Features

- White exterior & interior
- 20% more efficient than any walk-in series on the market
- Available in nominal sizes from 6' x 8' up to 10' x 12', all 7'6" high with floor standard (indoor models only)
- Foamed-in-place 4" panels with cam locks
- Top-mount drop in refrigeration system, with low noise level and R404A refrigerant (overall height is 10' with condenser installed, recommend ceiling height 11')
- 3 spring loaded heavy duty Kason door hinges standard
- 36" door with diamond tread kick plates and heated frames standard
- Heavy duty Kason door closer
- Heavy duty Kason door handle with lock and inside safety release
- Interior ramp standard
- Digital LED light standard
- Reinforced floor standard
- 48" ceiling mount LED standard
- Coolers maintain 35 °F – 38 °F
- 4" thick wall and ceiling panels with R-values of R-29 for coolers



For the best results of food preservation we recommend setting your refrigerator between 35°F to 38 °F

1. Don't forget to leave the unit some room to breathe!
2. Please clean the condenser frequently to give the unit more fresh air.



10 YEAR PANEL WARRANTY
5 YEAR REFRIGERATION WARRANTY
1 YEAR HARDWARE WARRANTY



REV. 08/25



"WE MAKE THE KITCHEN BETTER!"

ATOSA USA, INC.

Toll Free: 855-855-0399 Email: info@atosausa.com

www.atosa.com | www.atosausa.com

California, Colorado, Florida, Georgia, Illinois,

New Jersey, Ohio, Texas, Washington

SPECIFICATIONS

Models	Rated Current (A)	Voltage (V/Hz/Ph)	Breaker	HP	Refrigerant	Exterior Dimensions (inch)	Condensing Unit Weight (lb)	Evaporator Weight (lb)	Panel Weight (lb)
AWC0608-TF-IL/IR	12	208~240/60/1	30	1.5	R404A	72 x 96 x 117	216	218	1120
AWC0808-TF-IL/IR	12	208~240/60/1	30	1.5	R404A	96 x 96 x 117	216	218	1318
AWC0810-TF-IL/IR	12	208~240/60/1	30	1.5	R404A	96 x 120 x 117	216	218	1517
AWC1010-TF-IL/IR	12	208~240/60/1	30	1.5	R404A	120 x 120 x 117	216	218	1743
AWC1012-TF-IL/IR	30	208~240/60/1	40	3	R404A	120 x 144 x 117	243	218	1967

PLAN VIEW

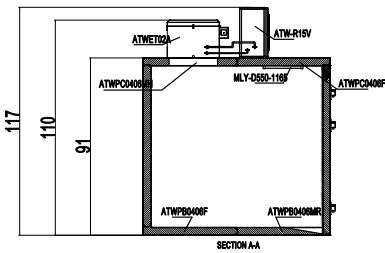

AWC0608-TF-IL/IR

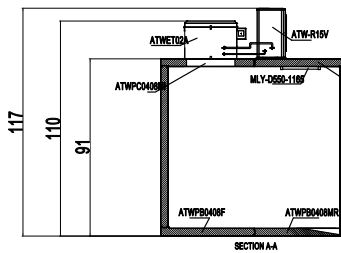

AWC0808-TF-IL/IR

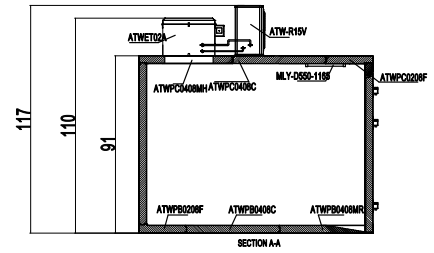

AWC0810-TF-IL/IR

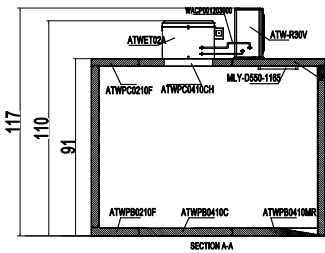
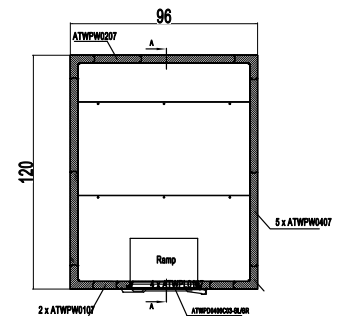
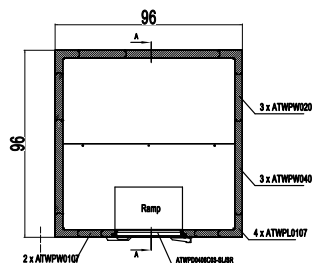
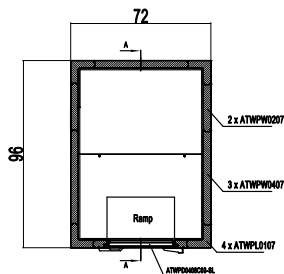

AWC1010-TF-IL/IR

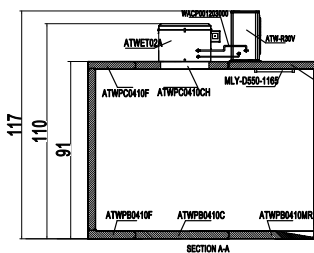
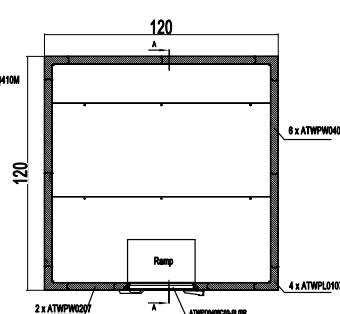

AWC1012-TF-IL/IR

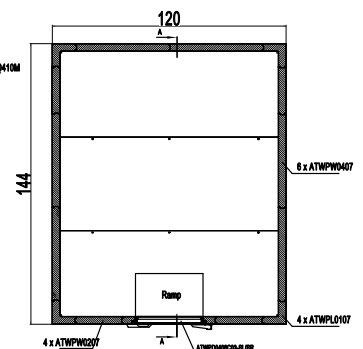



"WE MAKE THE KITCHEN BETTER!"

ATOSA USA, INC.

Toll Free: 855-855-0399 Email: info@atosausa.com

www.atosa.com | www.atosausa.com

California, Colorado, Florida, Georgia, Illinois,

New Jersey, Ohio, Texas, Washington

SHELVING UNITS CONFIGURATION

AWC0608-TF-IL/IR

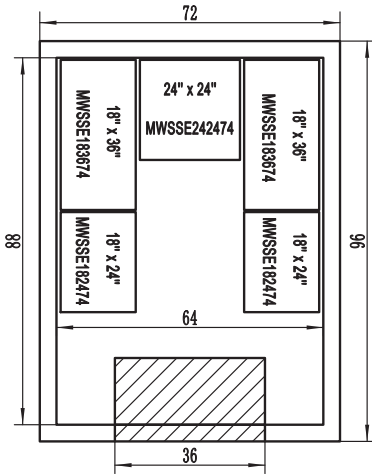

AWC0808-TF-IL/IR

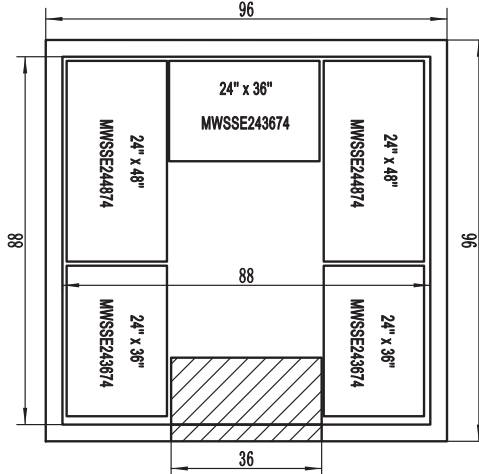

AWC1010-TF-IL/IR

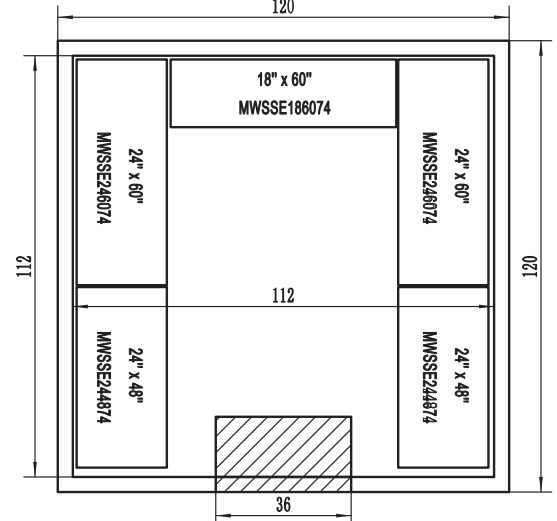

AWC0810-TF-IL/IR

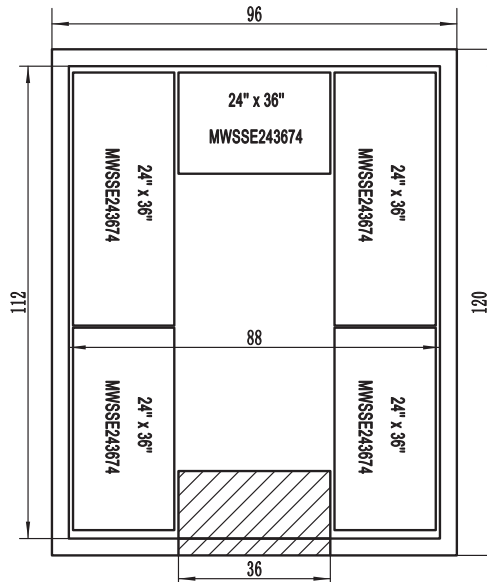

AWC1012-TF-IL/IR

