

## Reach-in Glass Door Refrigerator - Bottom-Mounted Series

- Stainless steel interior and exterior, Galvanized sheet back.
- Refrigeration system keeps food at safe temperature between 33°F and 41°F (0.5 °C to 5°C).
- Self-Closing doors with 90 degree stay-open feature.
- Shelves: Adjustable heavy-duty epoxy coated shelves.
- Door with 2 layers' tempered glass.
- New circulating air system, new designed air duct make the little temperature difference between top and bottom, better cooling efficiency
- Electronic control system makes it easy to adjust temperature set point and defrost frequency.
- Pre installed heavy-duty casters with brakes.
- EC fan motor, lower energy consumption, less noise, higher efficiency.
- Locks and keys included.
- Self-Closing doors with 90 degree stay-open feature.



**VRB27RG**



**VRB54RG**

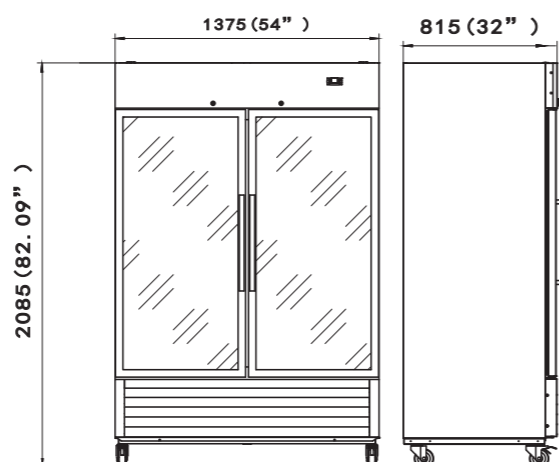
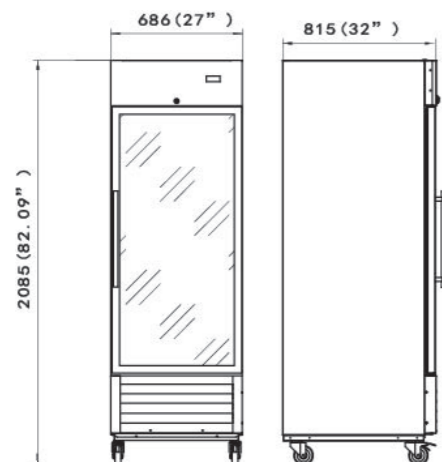

MODEL	DOORS	SHELVES	DIMENSION(WxDxH) inches mm	CAPACITY cu.ft. liters	HP	AMPS	VOLTAGE	PLUG TYPE
VRB27RG	1	3	27 *32 1/16*83 1/4 686*815*2115	594 21	1/5	2	115/60/1	5-15P
VRB54RG	2	6	54 1/8*32 1/16*83 1/4 1375*815*2115	1302 46	1/4	2.5	115/60/1	5-15P

## Reach-in Glass Door Freezer- Bottom-Mounted Series

- Stainless steel interior and exterior, Galvanized sheet back.
- Refrigeration system keeps food at safe temperature between -8°F and 0 °F (-22 °C to -18 °C).
- Self-Closing doors with 90 degree stay-open feature.
- Shelves: Adjustable heavy-duty epoxy coated shelves.
- 3 layers' tempered glass door with heater.
- New circulating air system, new designed air duct make the little temperature difference between top and bottom, better cooling efficiency
- Electronic control system makes it easy to adjust temperature set point and defrost frequency.
- Pre installed heavy-duty casters with brakes.
- EC fan motor, lower energy consumption, less noise, higher efficiency.
- Locks and keys included.
- Self-Closing doors with 90 degree stay-open feature.



**VRB27FG**



**VRB54FG**

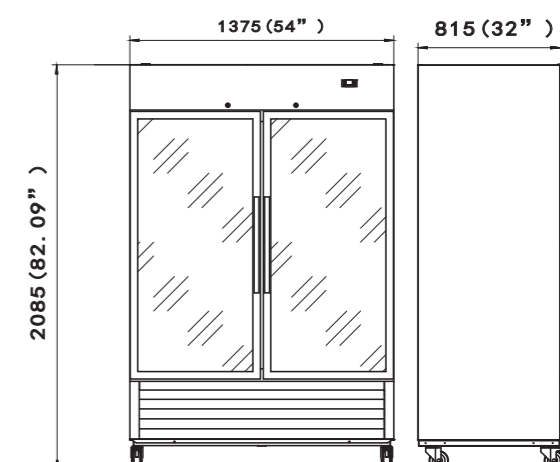
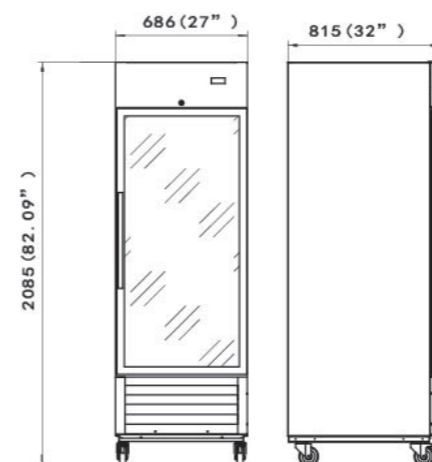

MODEL	DOORS	SHELVES	DIMENSION(WxDxH) inches mm	CAPACITY cu.ft. liters	HP	AMPS	VOLTAGE	PLUG TYPE
VRB27FG	1	3	27 *32 1/16*83 1/4 686*815*2115	594 21	1/3	3.2	115/60/1	5-15P
VRB54FG	2	6	54 1/8*32 1/16*83 1/4 1375*815*2115	1302 46	1/2	5.3	115/60/1	5-15P



VITLIFE AMERICA LLC  
4320 WINFIELD RD , WARRENVILLE, IL 60555  
Tel: 800 604 5402  
Email : info@vitlifecommercial.com  
www.vitlifecommercial.com



VITLIFE AMERICA LLC  
4320 WINFIELD RD , WARRENVILLE, IL 60555  
Tel: 800 604 5402  
Email : info@vitlifecommercial.com  
www.vitlifecommercial.com

## Under Counter Refrigerator - VUC Series

- Stainless steel interior and exterior, Galvanized sheet back.
- Refrigeration system keeps food at safe temperature between 33°F and 41°F (0.5 °C to 5°C).
- Self-Closing doors with 90 degree stay-open feature.
- Evaporation fan stop working when door is open, energy saving.
- Shelves: Adjustable heavy-duty epoxy coated shelves.
- Electronic control system makes it easy to adjust temperature set point and defrost frequency.
- Pre installed heavy-duty casters with brakes.
- EC fan motor, lower energy consumption, less noise, higher efficiency.
- Option of Backsplashes available.
- Option of different handles .



MODEL	DOORS	SHELVES	DIMENSION(WxDxH) inches mm	CAPACITY cu.ft. liters	HP	AMPS	VOLTAGE	PLUG TYPE
VUC29R	1	1	29*30*35 9/16 732*762*903	7.3 207	1/5	1.7	115/60/1	5-15P
VUC48R	2	2	48 1/4*30*35 9/16 1225*762*903	13.1 373	1/5	1.7	115/60/1	5-15P
VUC60R	2	2	60 1/4*30*35 9/16 1530*762*903	17 482	1/4	2.1	115/60/1	5-15P
VUC72R	3	3	72 11/16*30*35 9/16 1846*762*903	20.5 583	1/4	2.1	115/60/1	5-15P

## Under Counter Freezer- VUC Series

- Stainless steel interior and exterior, Galvanized sheet back.
- Refrigeration system keeps food at safe temperature between -8°F and 0 °F (-22 °C to -18 °C).
- Self-Closing doors with 90 degree stay-open feature.
- Evaporation fan stop working when door is open, energy saving.
- Shelves: Adjustable heavy-duty epoxy coated shelves.
- Option of different handles .
- Pre installed heavy-duty casters with brakes.
- Hot pipe anti-condensation, not just in the door frame, but also in the middle vertical mullion, instead of the electric wire heater, more safe, more energy saving.
- EC fan motor, lower energy consumption, less noise, higher efficiency.
- Option of Backsplashes available.
- Electronic control system makes it easy to adjust temperature set point and defrost frequency.



MODEL	DOORS	SHELVES	DIMENSION(WxDxH) inches mm	CAPACITY cu.ft. liters	HP	AMPS	VOLTAGE	PLUG TYPE
VUC29F	1	1	29*30*35 9/16 732*762*903	7.3 207	1/5	1.7	115/60/1	5-15P
VUC48F	2	2	48 1/4*30*35 9/16 1225*762*903	13.1 373	1/3	2.9	115/60/1	5-15P
VUC60F	2	2	60 1/4*30*35 9/16 1530*762*903	17 482	1/3	2.9	115/60/1	5-15P
VUC72F	3	3	72 11/16*30*35 9/16 1846*762*903	20.5 583	1/2	4.1	115/60/1	5-15P



VITLIFE AMERICA LLC  
4320 WINFIELD RD , WARRENVILLE, IL 60555  
Tel: 800 604 5402  
Email : info@vitlifecommercial.com  
www.vitlifecommercial.com



VITLIFE AMERICA LLC  
4320 WINFIELD RD , WARRENVILLE, IL 60555  
Tel: 800 604 5402  
Email : info@vitlifecommercial.com  
www.vitlifecommercial.com

## Under Counter Refrigerator With Backsplash Series

- Stainless steel interior and exterior, Galvanized sheet back.
- Refrigeration system keeps food at safe temperature between 33°F and 41°F (0.5 °C to 5°C).
- Self-Closing doors with 90 degree stay-open feature.
- Evaporation fan stop working when door is open, energy saving.
- Shelves: Adjustable heavy-duty epoxy coated shelves.
- Electronic control system makes it easy to adjust temperature set point and defrost frequency.
- Pre installed heavy-duty casters with brakes.
- EC fan motor, lower energy consumption, less noise, higher efficiency.
- Option of Backsplashes available.
- Option of different handles .



MODEL	DOORS	SHELVES	DIMENSION(WxDxH) inches mm	CAPACITY cu.ft. liters	HP	AMPS	VOLTAGE	PLUG TYPE
VUC29RW	1	1	29*30*39 9/16 732*762*992	7.3 207	1/5	1.7	115/60/1	5-15P
VUC48RW	2	2	48 1/4*30*39 9/16 1225*762*992	13.1 373	1/5	1.7	115/60/1	5-15P
VUC60RW	2	2	60 1/4*30*39 9/16 1530*762*992	17 482	1/4	2.1	115/60/1	5-15P
VUC72RW	3	3	72 11/16*30*39 9/16 1846*762*992	20.5 583	1/4	2.1	115/60/1	5-15P

## Under Counter Freezer With Backsplash Series

- Stainless steel interior and exterior, Galvanized sheet back.
- Refrigeration system keeps food at safe temperature between -8°F and 0 °F (-22 °C to -18 °C).
- Self-Closing doors with 90 degree stay-open feature.
- Evaporation fan stop working when door is open, energy saving.
- Shelves: Adjustable heavy-duty epoxy coated shelves.
- Option of different handles .
- Pre installed heavy-duty casters with brakes.
- Hot pipe anti-consensation, not just in the door frame, but also in the middle vertical mullion, instead of the electric wire heater, more safe, more energy saving.
- EC fan motor, lower energy consumption, less noise, higher efficiency.
- Option of Backsplashes available.
- Electronic control system makes it easy to adjust temperature set point and defrost frequency.



MODEL	DOORS	SHELVES	DIMENSION(WxDxH) inches mm	CAPACITY cu.ft. liters	HP	AMPS	VOLTAGE	PLUG TYPE
VUC29FW	1	1	29*30*39 9/16 732*762*992	7.3 207	1/5	1.7	115/60/1	5-15P
VUC48FW	2	2	48 1/4*30*39 9/16 1225*762*992	13.1 373	1/3	2.9	115/60/1	5-15P
VUC60FW	2	2	60 1/4*30*39 9/16 1530*762*992	17 482	1/3	2.9	115/60/1	5-15P
VUC72FW	3	3	72 11/16*30*39 9/16 1846*762*992	20.5 583	1/2	4.1	115/60/1	5-15P

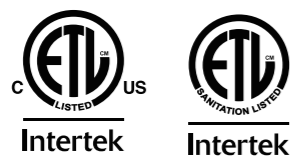

VITLIFE AMERICA LLC  
4320 WINFIELD RD ,WARRENVILLE, IL 60555  
Tel: 800 604 5402  
Email : info@vitlifecommercial.com  
www.vitlifecommercial.com



VITLIFE AMERICA LLC  
4320 WINFIELD RD ,WARRENVILLE, IL 60555  
Tel: 800 604 5402  
Email : info@vitlifecommercial.com  
www.vitlifecommercial.com

# Sandwich/Salad Prep Table

- Stainless steel interior and exterior, Galvanized sheet back.
- Refrigeration system keeps food at safe temperature between 33°F and 41°F (0.5 °C to 5°C).
- Self-Closing doors with 90 degree stay-open feature.
- Cutting boards and pans available.
- Shelves: Adjustable heavy-duty epoxy coated shelves.
- Option of different handles .
- Electronic control system makes it easy to adjust temperature set point and defrost frequency.
- Pre installed heavy-duty casters with brakes.
- Evaporation fan stop working when door is open, energy saving.
- EC fan motor, lower energy consumption, less noise, higher efficiency.



MODEL	DOORS	SHELVES	DIMENSION(WxDxH) inches mm	CAPACITY cu.ft. liters	HP	AMPS	VOLTAGE	PLUG TYPE
VSP29	1	1	29*30*42 5/8 732*762*1082	7.6 215	1/5	1.7	115/60/1	5-15P
VSP48	2	2	48 1/4*30*42 5/8 1225*762*1082	13.8 390	1/5	1.7	115/60/1	5-15P
VSP60	2	2	60 1/4*30*42 5/8 1530*762*1082	17.8 505	1/4	2.1	115/60/1	5-15P
VSP72	3	3	72 11/16*30*42 5/8 1846*762*1082	21.2 601	1/4	2.1	115/60/1	5-15P

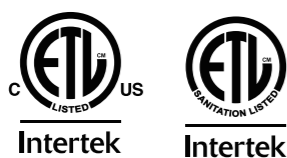

VITLIFE AMERICA LLC  
 4320 WINFIELD RD ,WARRENVILLE, IL 60555  
 Tel: 800 604 5402  
 Email : info@vitlifecommercial.com  
 www.vitlifecommercial.com

# Mega top Sandwich/Salad Prep Table

- Stainless steel interior and exterior, Galvanized sheet back.
- Refrigeration system keeps food at safe temperature between 33°F and 41°F (0.5 °C to 5°C).
- Self-Closing doors with 90 degree stay-open feature.
- Cutting boards and pans available.
- Shelves: Adjustable heavy-duty epoxy coated shelves.
- Option of different handles .
- Electronic control system makes it easy to adjust temperature set point and defrost frequency.
- Pre installed heavy-duty casters with brakes.
- Evaporation fan stop working when door is open, energy saving.
- EC fan motor, lower energy consumption, less noise, higher efficiency.

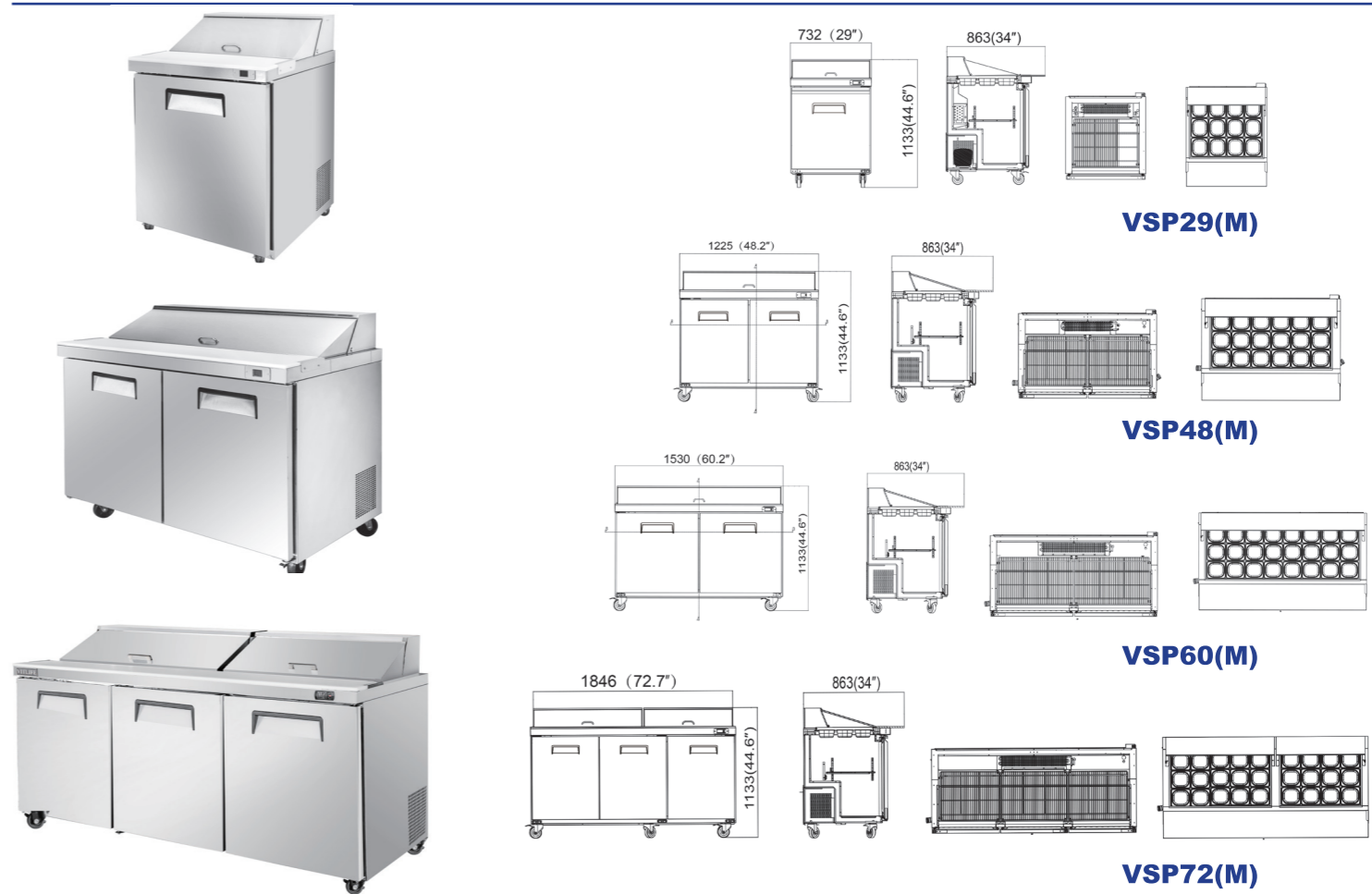

MODEL	DOORS	SHELVES	DIMENSION(WxDxH) inches mm	CAPACITY cu.ft. liters	HP	AMPS	VOLTAGE	PLUG TYPE
VSP29(M)	1	1	29*30*42 5/8 732*762*1082	7.6 215	1/5	1.7	115/60/1	5-15P
VSP48(M)	2	2	48 1/4*30*42 5/8 1225*762*1082	13.8 390	1/5	1.7	115/60/1	5-15P
VSP60(M)	2	2	60 1/4*30*42 5/8 1530*762*1082	17.8 505	1/4	2.1	115/60/1	5-15P
VSP72(M)	3	3	72 11/16*30*42 5/8 1846*762*1082	21.2 601	1/4	2.1	115/60/1	5-15P



VITLIFE AMERICA LLC  
 4320 WINFIELD RD ,WARRENVILLE, IL 60555  
 Tel: 800 604 5402  
 Email : info@vitlifecommercial.com  
 www.vitlifecommercial.com

# Pizza Prep Table

- Stainless steel interior and exterior, Galvanized sheet back.
- Refrigeration system keeps food at safe temperature between 33°F and 41°F (0.5 °C to 5°C).
- Self-Closing doors with 90 degree stay-open feature.
- Cutting boards and pans available.
- Shelves: Adjustable heavy-duty epoxy coated shelves.
- Option of different handles .
- Electronic control system makes it easy to adjust temperature set point and defrost frequency.
- Pre installed heavy-duty casters with brakes.
- Evaporation fan stop working when door is open, energy saving.
- EC fan motor, lower energy consumption, less noise, higher efficiency.

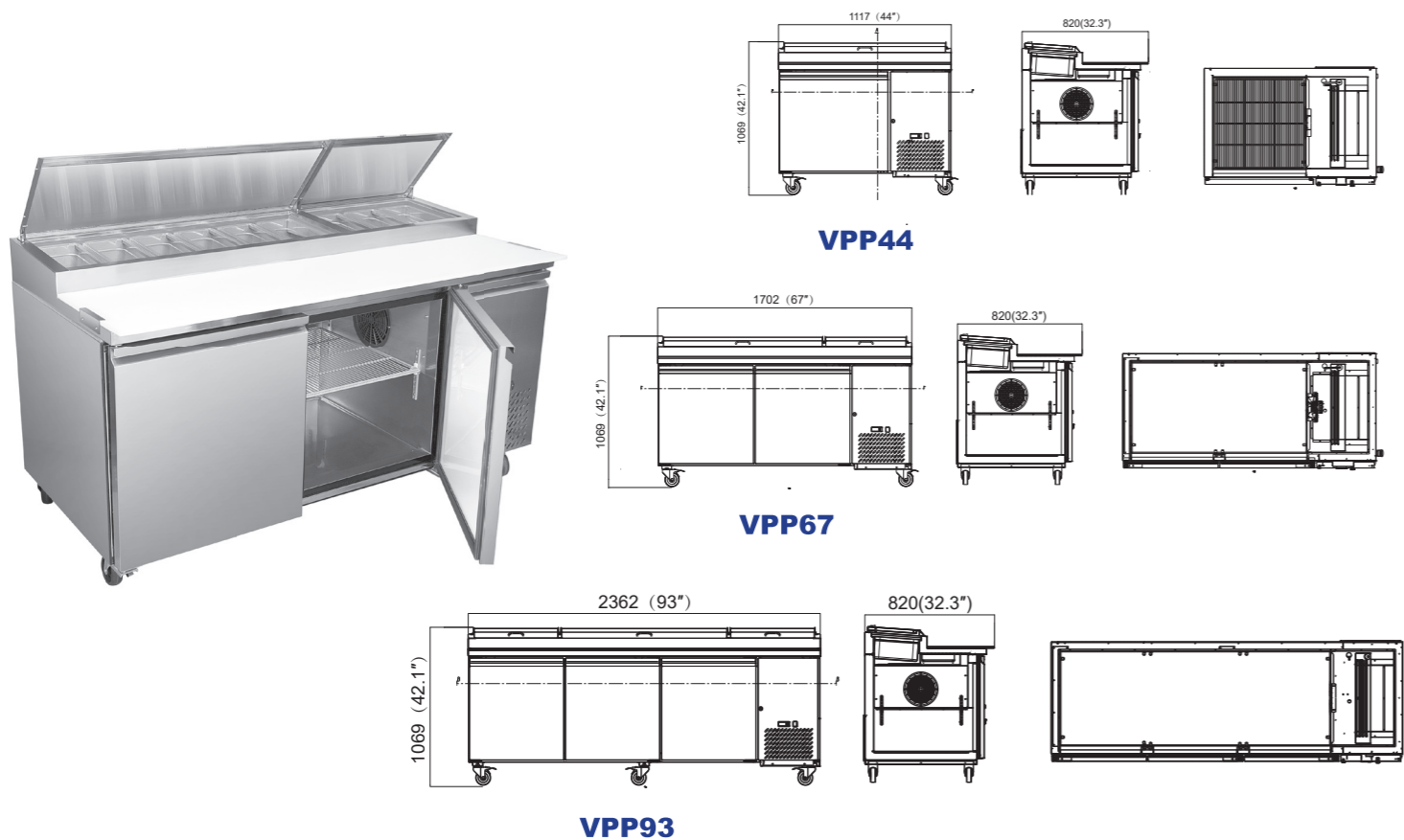

MODEL	DOORS	SHELVES	DIMENSION(WxDxH) inches mm	CAPACITY cu.ft. liters	HP	AMPS	VOLTAGE	PLUG TYPE
VPP44	1	1	44*32 5/16*42 1/16 1142*880*1136	10.9 310	1/5	1.7	115/60/1	5-15P
VPP67	2	2	67 *32 5/16*42 1/16 1727*880*1136	20.9 592	1/3	2.9	115/60/1	5-15P
VPP93	3	3	93*32 5/16*42 1/16 2387*880*1136	30.8 872	1/2	4.1	115/60/1	5-15P

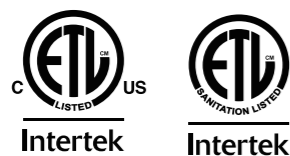

VITLIFE AMERICA LLC  
 4320 WINFIELD RD ,WARRENVILLE, IL 60555  
 Tel: 800 604 5402  
 Email : info@vitlifecommercial.com  
 www.vitlifecommercial.com

# Chef Base Refrigerator

- Stainless steel interior and exterior, Galvanized sheet back.
- Stainless steel top equipped with a marine edge enables the unit's top to contain drips and spills for easy cleanup.
- Refrigeration system keeps food at safe temperatures,between 33°F and 41°F (0.5°C to 5°C).
- Preinstalled heavy-duty casters with brakes.
- Electronic control system makes it easy to adjust temperature set point and defrost frequency.
- Evaporation fan stop working when door is open, energy saving.
- Heavy-duty pull handles.

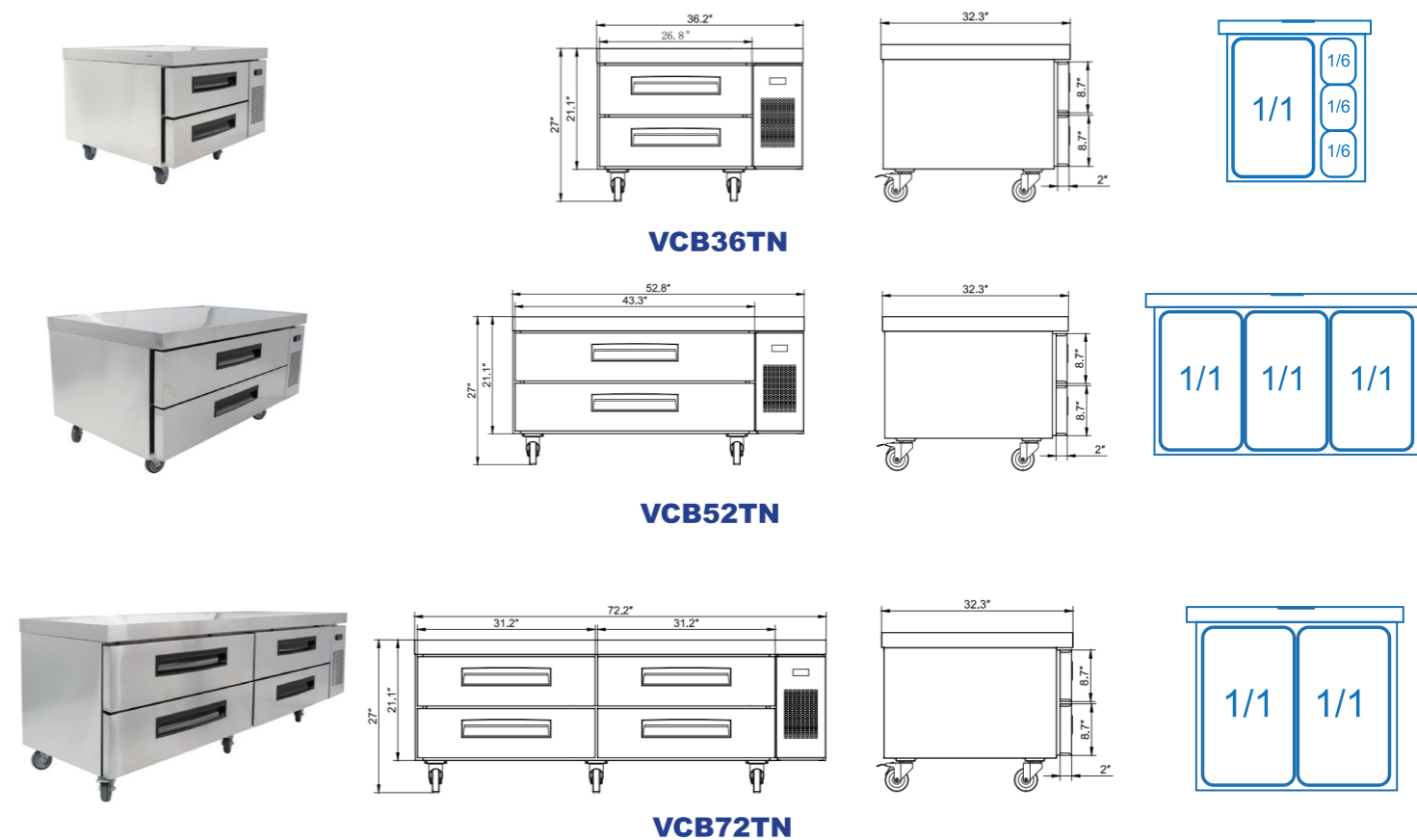

MODEL	DOORS	GN PANS FOR EVERY DRAWER	DIMENSION(WxDxH) inches mm	CAPACITY cu.ft. liters	HP	AMPS	VOLTAGE	PLUG TYPE
VCB36TN	2	3*1/6+1*1/1	44*32 5/16*42 1/16 1142*880*1136	10.9 310	1/5	2.6	115/60/1	5-15P
VCB52TN	2	3*1/1	67 *32 5/16*42 1/16 1727*880*1136	20.9 592	1/5	2.7	115/60/1	5-15P
VCB72TN	4	2*1/1	93*32 5/16*42 1/16 2387*880*1136	30.8 872	1/5	3.1	115/60/1	5-15P



VITLIFE AMERICA LLC  
 4320 WINFIELD RD ,WARRENVILLE, IL 60555  
 Tel: 800 604 5402  
 Email : info@vitlifecommercial.com  
 www.vitlifecommercial.com

# Refrigerated Topping Unit

- Interior and exterior stainless steel material for high level product.
- High quality famous compressor.
- Electronic control system makes it easy to adjust temperature set point and defrost frequency.
- Accept GN1/6 pans range.
- CFC free foaming.
- Agjustable feet.
- Refrigeration system keeps food at safe temperature between 32°F and 50 °F (0 °C to 10°C).



**VRTR4**

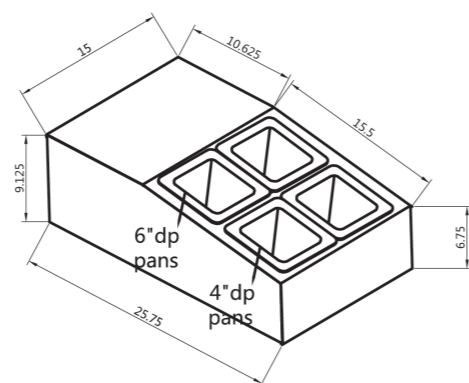

**VRTR8**

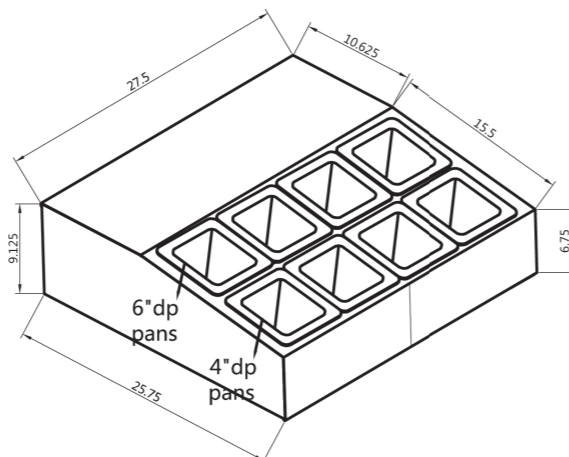

MODEL	GN PANS	DIMENSION(WxDxH) inches mm	HP	AMPS	VOLTAGE	PLUG TYPE
VRTR4	GN1/6*4	14 15/16*25 13/16*9 5/16 379*656*236	1/5	1.4	115/60/1	5-15P
VRTR8	GN1/6*8	27 1/2*25 13/16*9 5/16 699*656*236	1/5	1.4	115/60/1	5-15P

# VRX

- Interior and exterior stainless steel material for high level product.
- High quality famous compressor.
- Electronic control system makes it easy to adjust temperature set point and defrost frequency.
- CFC free foaming.
- Agjustable feet.
- Refrigeration system keeps food at safe temperature between 33°F and 41 °F (0.5 °C to 5°C).
- Option of LED lighting.



**VVRX with glass top**



**VVRX with stainless steel lid**

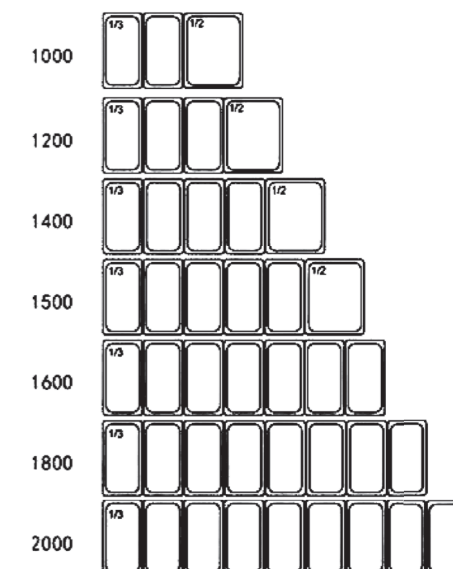

MODEL	GN PANS	DIMENSION(WxDxH) inches mm	HP	AMPS	VOLTAGE	PLUG TYPE
VVRX1200/380	GN1/3*3+ GN1/2*1	47 1/4*15 1/2*17 1/8 1200*395*435	1/5	1.4	115/60/1	5-15P
VVRX1500/380	GN1/3*5+ GN1/2*1	59*15 1/2*17 1/8 1500*395*435	1/5	1.4	115/60/1	5-15P
VVRX2000/380	GN1/3*9	78 3/4*15 1/2*17 1/8 2000*395*435	1/5	1.4	115/60/1	5-15P

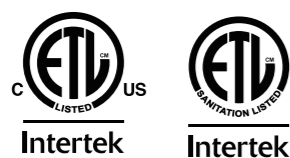

VITLIFE AMERICA LLC  
4320 WINFIELD RD , WARRENVILLE, IL 60555  
Tel: 800 604 5402  
Email : info@vitlifecommercial.com  
www.vitlifecommercial.com



VITLIFE AMERICA LLC  
4320 WINFIELD RD , WARRENVILLE, IL 60555  
Tel: 800 604 5402  
Email : info@vitlifecommercial.com  
www.vitlifecommercial.com

# Upright Ventilated Chiller

- Exterior: Coated steel. Black or white finish available.  
Interior: Integrated Vacuum adsorption HIPS liner, easy to clean.
- Refrigeration system keeps food at safe temperature between 33°F and 41°F (0.5°C to 5°C).
- Shelves: Adjustable heavy-duty epoxy coated shelves.
- Option of external or full length handles .
- Locks and keys included.
- Electronic control system makes it easy to adjust temperature set point and defrost frequency.
- Leveling feet or casters are available.
- New circulating air system, new designed air duct make the little temperature difference between top and bottom, better cooling efficiency
- The door can be reversed left and right.
- Option of top LED lighting



MODEL	SHELVES	DIMENSION(WxDxH) inches mm	CAPACITY cu.ft. liters	HP	AMPS	VOLTAGE	PLUG TYPE
VBR200VW	2	23 3/8*25 3/4*34 5/8 595x655x880	4 115	1/5	1.5	115/60/1	5-15P
VBR400VW	4	23 3/8*26 1/8*74 1/8 595x662x1882	10.4 293	1/5	1.5	115/60/1	5-15P
VBR600VW	4	30 1/2*30*74 1/8 775x762x1882	18 510	1/4	2.0	115/60/1	5-15P

# Upright Ventilated Freezer

- Exterior: Coated steel. Black or white finish available.  
Interior: Integrated Vacuum adsorption HIPS liner, easy to clean.
- Refrigeration system keeps food at safe temperature between -8°F and 0 °F (-22 °C to -18 °C).
- Shelves: Adjustable heavy-duty epoxy coated shelves.
- Option of external or full length handles .
- Locks and keys included.
- Electronic control system makes it easy to adjust temperature set point and defrost frequency.
- Leveling feet or casters are available.
- New circulating air system, new designed air duct make the little temperature difference between top and bottom, better cooling efficiency
- The door can be reversed left and right.
- Option of top LED lighting



MODEL	SHELVES	DIMENSION(WxDxH) inches mm	CAPACITY cu.ft. liters	HP	AMPS	VOLTAGE	PLUG TYPE
VBF200VW	2	23 3/8*25 3/4*34 5/8 595x655x880	4 115	1/5	1.9	115/60/1	5-15P
VBF400VW	4	23 3/8*26 1/8*74 1/8 595x662x1882	10.4 293	1/3	3.3	115/60/1	5-15P
VBF600VW	4	30 1/2*30*74 1/8 775x762x1882	18 510	1/2	5.5	115/60/1	5-15P



VITLIFE AMERICA LLC  
4320 WINFIELD RD , WARRENVILLE, IL 60555  
Tel: 800 604 5402  
Email : info@vitlifecommercial.com  
www.vitlifecommercial.com



VITLIFE AMERICA LLC  
4320 WINFIELD RD , WARRENVILLE, IL 60555  
Tel: 800 604 5402  
Email : info@vitlifecommercial.com  
www.vitlifecommercial.com

# Upright Ventilated Chiller-Glass door series

- Exterior: Coated steel. Black or white finish available.  
Interior: Integrated Vacuum adsorption HIPS liner, easy to clean.
- Refrigeration system keeps food at safe temperature between 33°F and 41 °F (0.5°C to 5°C).
- Shelves: Adjustable heavy-duty epoxy coated shelves.
- Option of external or full length handles .
- Locks and keys included.
- Electronic control system makes it easy to adjust temperature set point and defrost frequency.
- Leveling feet or casters are available.
- New circulating air system, new designed air duct make the little temperature difference between top and bottom, better cooling efficiency.
- Top LED lighting.
- Aluminum alloy door frame and 2 layers' tempered glass.

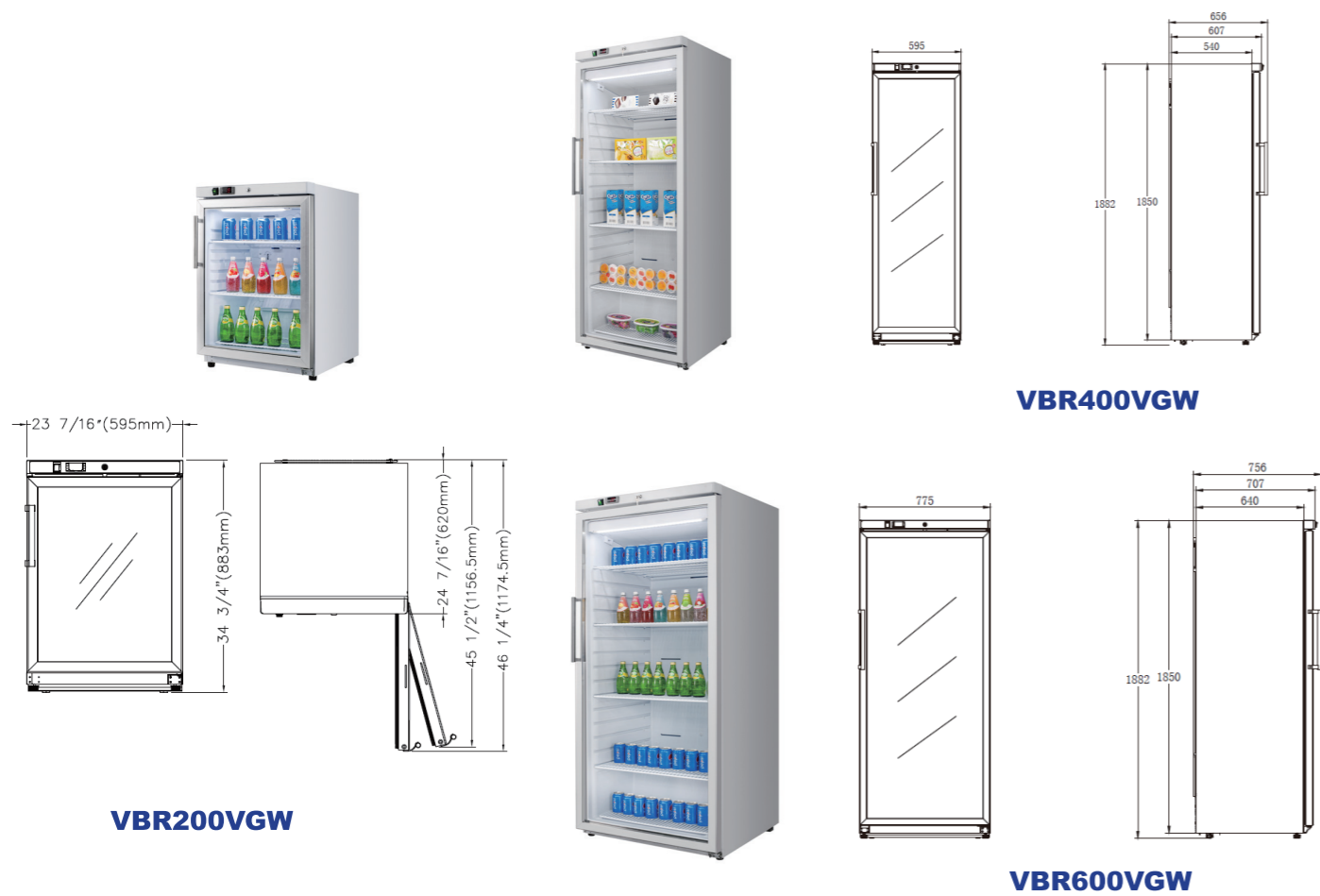

MODEL	SHELVES	DIMENSION(WxDxH) inches mm	CAPACITY cu.ft. liters	HP	AMPS	VOLTAGE	PLUG TYPE
VBR200VGW	2	23 3/8*25 3/4*34 5/8 595x655x880	4 115	1/6	1.5	115/60/1	5-15P
VBR400VGW	4	23 3/8*26 1/8*74 1/8 595x662x1882	10.4 293	1/6	1.5	115/60/1	5-15P
VBR600VGW	4	30 1/2*30*74 1/8 775x762x1882	18 510	1/5	2.0	115/60/1	5-15P

# Upright Ventilated Chiller-Glass door series

- Exterior: Coated steel. Black or white finish available.  
Interior: Integrated Vacuum adsorption HIPS liner, easy to clean.
- Refrigeration system keeps food at safe temperature between -8°F and 0 °F (-22 °C to -18 °C).
- Shelves: Adjustable heavy-duty epoxy coated shelves.
- Option of external or full length handles .
- Locks and keys included.
- Electronic control system makes it easy to adjust temperature set point and defrost frequency.
- Leveling feet or casters are available.
- New circulating air system, new designed air duct make the little temperature difference between top and bottom, better cooling efficiency.
- Top LED lighting.
- Aluminum alloy door frame and 3 layers' tempered glass with heater.

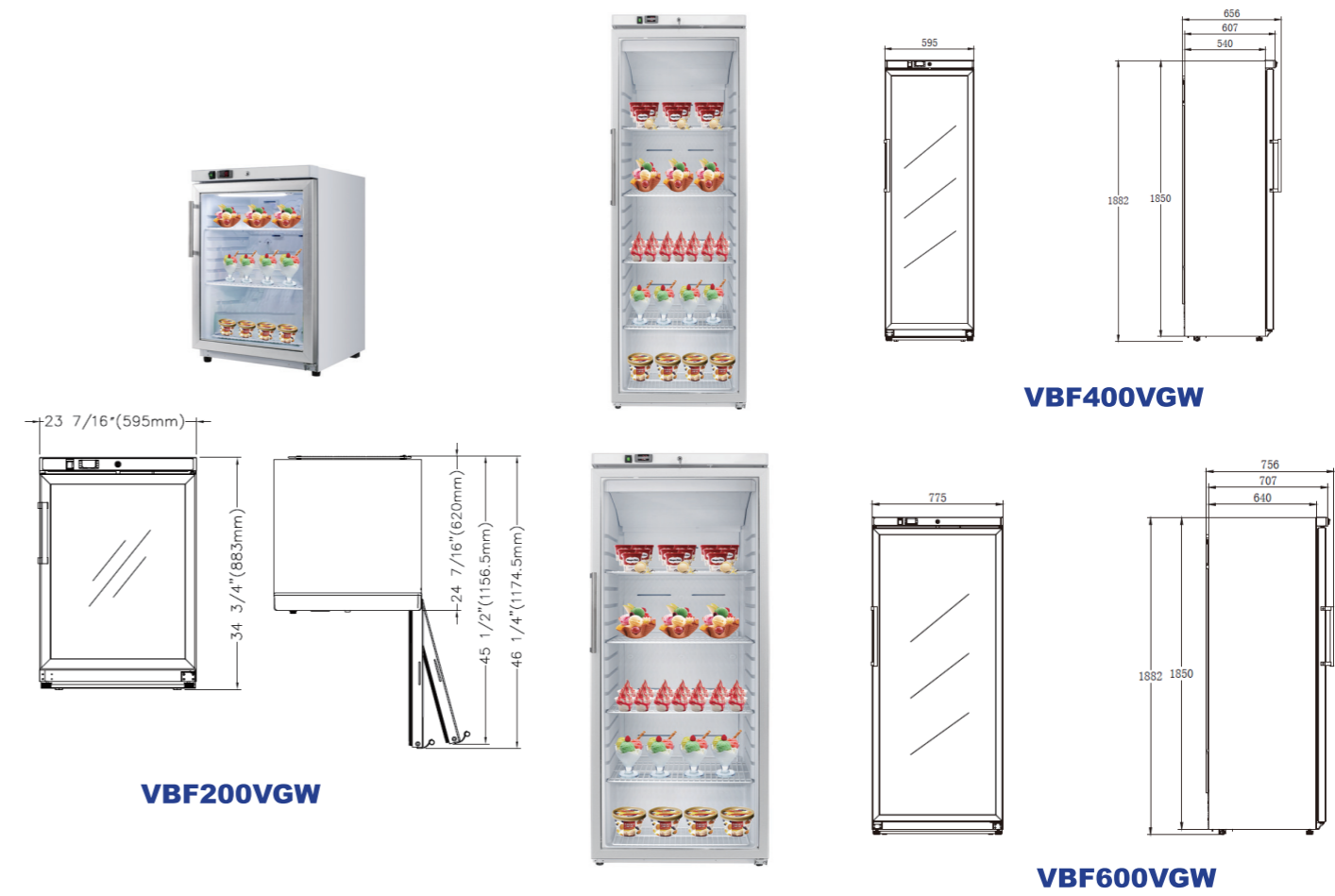

MODEL	SHELVES	DIMENSION(WxDxH) inches mm	CAPACITY cu.ft. liters	HP	AMPS	VOLTAGE	PLUG TYPE
VBF200VGW	2	23 3/8*25 3/4*34 5/8 595x655x880	4 115	1/5	2.3	115/60/1	5-15P
VBF400VGW	4	23 3/8*26 1/8*74 1/8 595x662x1882	10.4 293	1/3	3.3	115/60/1	5-15P
VBF600VGW	4	30 1/2*30*74 1/8 775x762x1882	18 510	1/2	5.7	115/60/1	5-15P

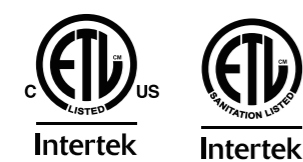

VITLIFE AMERICA LLC  
4320 WINFIELD RD , WARRENVILLE, IL 60555  
Tel: 800 604 5402  
Email : info@vitlifecommercial.com  
www.vitlifecommercial.com



VITLIFE AMERICA LLC  
4320 WINFIELD RD , WARRENVILLE, IL 60555  
Tel: 800 604 5402  
Email : info@vitlifecommercial.com  
www.vitlifecommercial.com

# Back Bar cooler-Swing doors series

- Exterior: Coated steel.  
Interior: Integrated Vacuum adsorption HIPS liner, easy to clean.
- Refrigeration system keeps food at safe temperature between 36°F and 50 °F (2°C to 10°C).
- Shelves: Adjustable heavy-duty epoxy coated shelves.
- Electronic control system makes it easy to adjust temperature set point and defrost frequency.
- TOP LED lighting.
- Locks and keys included.

# Back Bar cooler-Sliding doors series

- Exterior: Coated steel.  
Interior: Integrated Vacuum adsorption HIPS liner, easy to clean.
- Refrigeration system keeps food at safe temperature between 36°F and 50 °F (2°C to 10°C).
- Shelves: Adjustable heavy-duty epoxy coated shelves.
- Glass doors self-closing by gravity.
- Electronic control system makes it easy to adjust temperature set point and defrost frequency.
- Top LED lighting.
- Locks and keys included.



**VBBD238H**



**VBBD238S**



**VVBS138H**

**VBBT338H**



**VBBT338S**

MODEL	DOORS	SHELVES	DIMENSION(WxDxH) inches mm	CAPACITY cu.ft. liters	HP	AMPS	VOLTAGE	PLUG TYPE
VVBS138H	1	2	23 5/8*20 1/2*35 3/8 600*520*900	4.7 134	1/5	0.9	115/60/1	5-15P
VBBD238H	2	4	35 3/8*20 1/2*35 3/8 900*520*900	7.5 212	1/5	1.4	115/60/1	5-15P
VBBT338H	3	6	53 1/8*20 1/2*35 3/8 1350*520*900	11.6 328	1/4+	2.1	115/60/1	5-15P

MODEL	DOORS	SHELVES	DIMENSION(WxDxH) inches mm	CAPACITY cu.ft. liters	HP	AMPS	VOLTAGE	PLUG TYPE
VBBD238S	2	4	35 3/8*20 1/2*35 3/8 900*520*900	7.5 212	1/5	1.4	115/60/1	5-15P
VBBT338S	3	6	53 1/8*20 1/2*35 3/8 1350*520*900	11.6 328	1/4+	2.1	115/60/1	5-15P

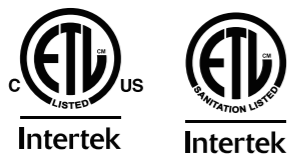

VITLIFE AMERICA LLC  
4320 WINFIELD RD, WARRENVILLE, IL 60555  
Tel: 800 604 5402  
Email : info@vitlifecommercial.com  
www.vitlifecommercial.com



VITLIFE AMERICA LLC  
4320 WINFIELD RD, WARRENVILLE, IL 60555  
Tel: 800 604 5402  
Email : info@vitlifecommercial.com  
www.vitlifecommercial.com

# Merchandising Swing Glass Door Refrigerator

- Ventilated cooling system, auto defrost.
- Exterior: Coated steel.  
Interior: Integrated Vacuum adsorption HIPS liner, easy to clean.
- Refrigeration system keeps food at safe temperature between 33°F and 41°F (0.5°C to 5°C).

- Shelves: Adjustable heavy-duty epoxy coated shelves.
- Electronic control system makes it easy to adjust temperature set point and defrost frequency.
- LED lighting.
- C: with canopy T: without canopy



MODEL	DOORS	SHELVES	DIMENSION(WxDxH) inches mm	CAPACITY cu.ft. liters	HP	AMPS	VOLTAGE	PLUG TYPE
VSC188VCW	1	4	19 5/8*23 1/2*60 1/4 500*596*1531	6.4 181	1/5	2.2	115/60/1	5-15P
VSC198VTW	1	4	19 5/8*23 1/2*60 1/4 500*596*1531	6.6 188	1/5	2.2	115/60/1	5-15P
VSC288VCW	1	4	19 5/8*23 1/2*70 7/8 550*596*1801	8.8 249	1/5	2.3	115/60/1	5-15P
VSC298VTW	1	4	19 5/8*23 1/2*70 7/8 550*596*1801	9.1 258	1/5	2.3	115/60/1	5-15P
VSC388VCW	1	4	23 3/8*24 5/8*76 5/8 595*626*1946	12.3 348	1/5	2.4	115/60/1	5-15P
VSC398VTW	1	4	23 3/8*24 5/8*76 5/8 595*626*1946	12.6 356	1/5	2.4	115/60/1	5-15P
VSC488VCW	1	4	27 1/2*26 5/8*76 5/8 700*676*1946	16.5 468	1/5	2.6	115/60/1	5-15P
VSC498VTW	1	4	27 1/2*26 5/8*76 5/8 700*676*1946	16.9 478	1/5	2.6	115/60/1	5-15P

# Merchandising Swing Glass Door Refrigerator

- Ventilated cooling system, auto defrost.
- Exterior: Coated steel.  
Interior: Integrated Vacuum adsorption HIPS liner, easy to clean.
- Refrigeration system keeps food at safe temperature between 33°F and 41°F (0.5°C to 5°C).

- Shelves: Adjustable heavy-duty epoxy coated shelves.
- Electronic control system makes it easy to adjust temperature set point and defrost frequency.
- LED lighting.
- C: with canopy T: without canopy

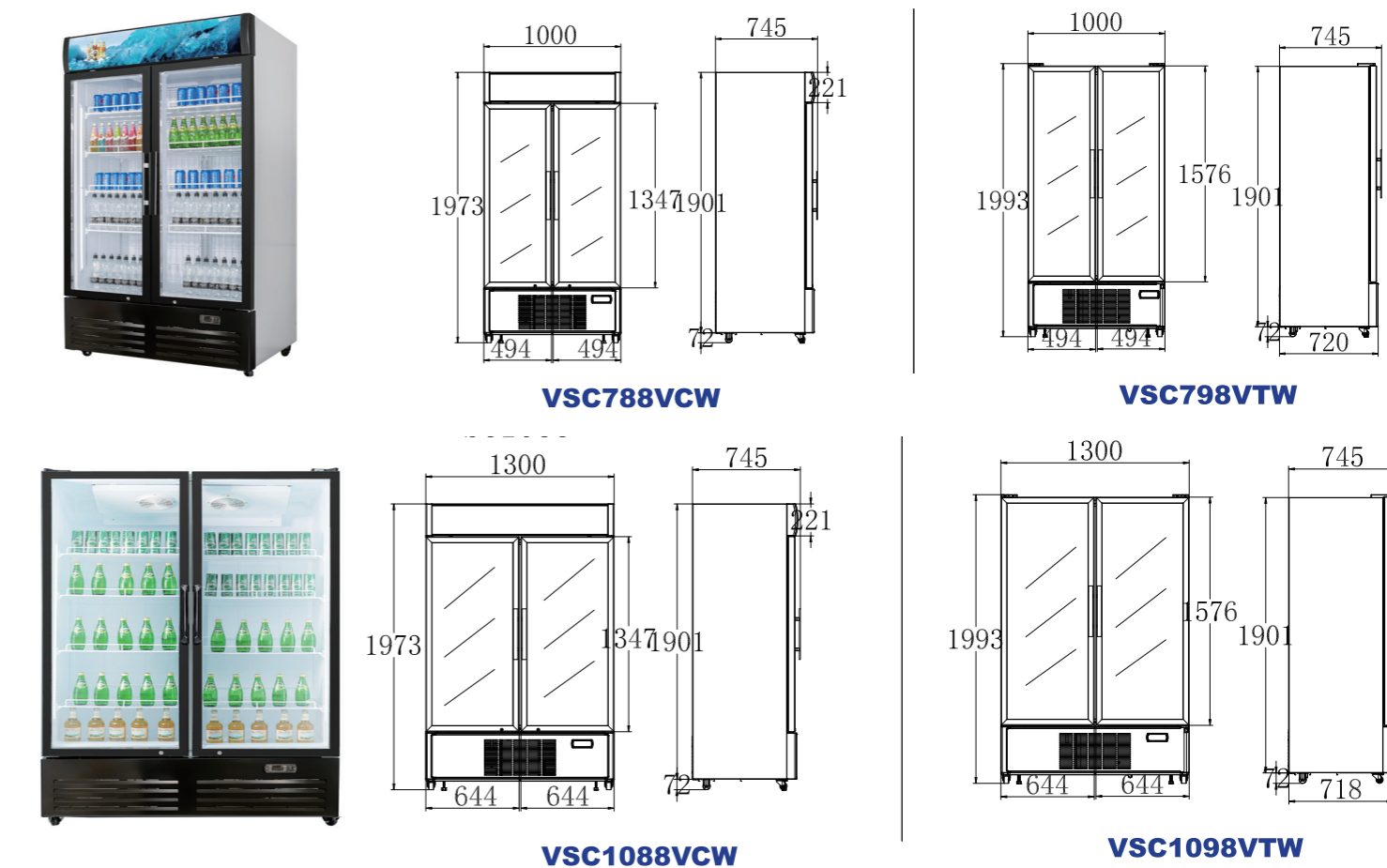

MODEL	DOORS	SHELVES	DIMENSION(WxDxH) inches mm	CAPACITY cu.ft. liters	HP	AMPS	VOLTAGE	PLUG TYPE
VSC788VCW	2	8	39 3/8*29 3/8*77 5/8 1000*745*1973	26 736	1/4+	6	115/60/1	5-15P
VSC798VTW	2	8	39 3/8*29 3/8*77 5/8 1000*745*1973	26.5 751	1/4+	6	115/60/1	5-15P
VSC1088VCW	2	8	51 1/8*29 3/8*77 5/8 1300*745*1973	35.3 1001	1/4+	6	115/60/1	5-15P
VSC1098VTW	2	8	51 1/8*29 3/8*77 5/8 1300*745*1973	36 1020	1/4+	6	115/60/1	5-15P



VITLIFE AMERICA LLC  
4320 WINFIELD RD, WARRENVILLE, IL 60555  
Tel: 800 604 5402  
Email: info@vitlifecommercial.com  
www.vitlifecommercial.com



VITLIFE AMERICA LLC  
4320 WINFIELD RD, WARRENVILLE, IL 60555  
Tel: 800 604 5402  
Email: info@vitlifecommercial.com  
www.vitlifecommercial.com

# Merchandising Sliding Door Refrigerator

- Ventilated cooling system, auto defrost.
- Exterior: Coated steel.  
Interior: Integrated Vacuum adsorption HIPS liner, easy to clean.
- Refrigeration system keeps food at safe temperature between 33°F and 41°F (0.5°C to 5°C).
- Shelves: Adjustable heavy-duty epoxy coated shelves.
- Electronic control system makes it easy to adjust temperature set point and defrost frequency.
- LED lighting.
- C: with canopy T: without canopy

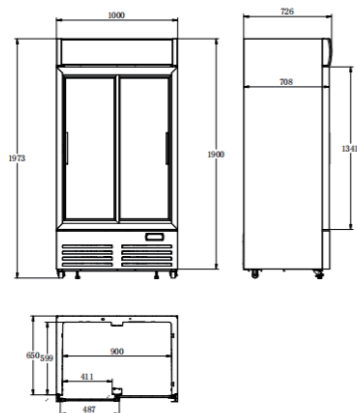

**VSC788VCS**

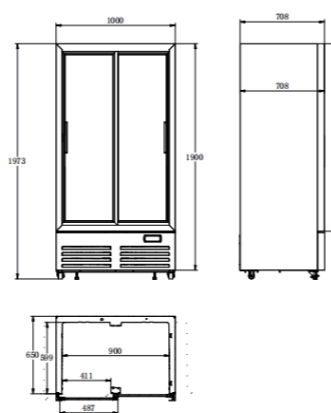

**VSC798VTS**

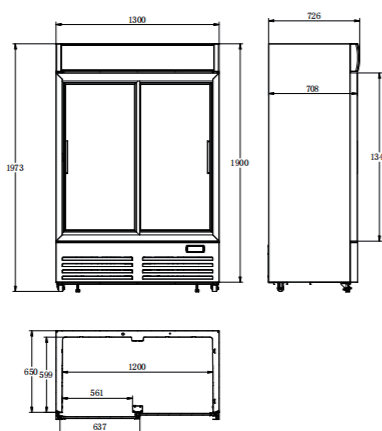

**VSC1088VCS**

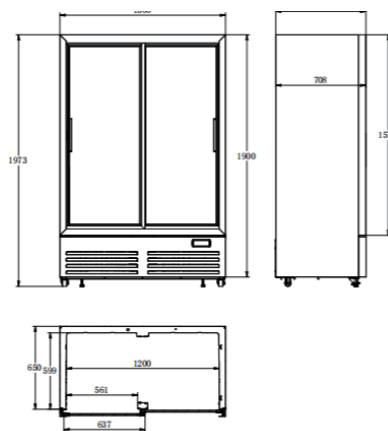

**VSC1098VTS**

MODEL	DOORS	SHELVES	DIMENSION(WxDxH) inches mm	CAPACITY cu.ft. liters	HP	AMPS	VOLTAGE	PLUG TYPE
VSC788VCS	2	8	39 3/8*29 3/8*77 5/8 1000*745*1973	26 736	1/4+	6	115/60/1	5-15P
VSC798VTS	2	8	39 3/8*29 3/8*77 5/8 1000*745*1973	26.5 751	1/4+	6	115/60/1	5-15P
VSC1088VCS	2	8	51 1/8*29 3/8*77 5/8 1300*745*1973	35.3 1001	1/4+	6	115/60/1	5-15P
VSC1098VTS	2	8	51 1/8*29 3/8*77 5/8 1300*745*1973	36 1020	1/4+	6	115/60/1	5-15P



VITLIFE AMERICA LLC  
 4320 WINFIELD RD ,WARRENVILLE, IL 60555  
 Tel: 800 604 5402  
 Email : info@vitlifecommercial.com  
 www.vitlifecommercial.com

VITLIFE AMERICA LLC  
 4320 WINFIELD RD ,WARRENVILLE, IL 60555  
 Tel: 800 604 5402  
 Email : info@vitlifecommercial.com  
 www.vitlifecommercial.com