



SPEC SHEET

KoolMore 60 in. 8-Burner Commercial Outdoor Propane Gas Grill with Two 30 in. Griddles in Stainless-Steel, ETL Listed

Model: CGKIT6-G30G30

FEATURES

- Commercial Precision: High-performance grilling for outdoor kitchens.
- Durable Construction: 13-gauge 304 stainless steel resists rust and corrosion.
- Powerful Burners: Eight 16,000 BTU burners, spaced 5.75" apart, for even heat.
- Quick Start-Up: Reaches cooking temp in 5 minutes.
- Spacious Cooking Area: 1126 sq. in. for multiple dishes.
- Piezo Ignition: Reliable, hassle-free startups.
- Mobility: Large casters for easy movement.
- Accessories Included: 4 grates, 2 propane hoses, and side handle.
- Dual Propane Setup: Holders and hoses for two tanks extend cooking time.
- Assembly Required: Straightforward setup with all parts included.
- Griddle Plates: Two 30" griddles, each with 563 sq. in. carbon steel surface, 6" backsplash, drip pan, 16-gauge 304 stainless steel.
- ETL Certified & Warranty: Meets safety standards with a 1-year parts/labor warranty.

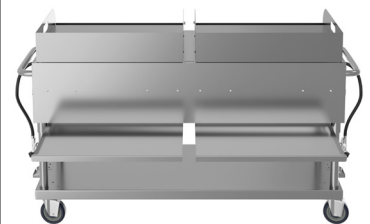
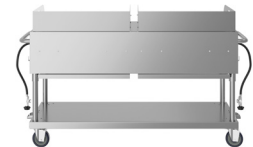
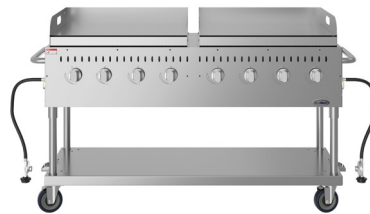

CLOSE UP IMAGES

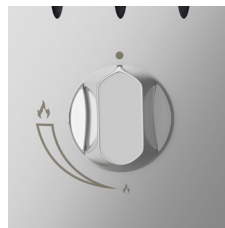

TECHNICAL SPECS

Dimensions

Length	60.8
Width	23.22
Grill Height	34.8
Assembled Height	40.8
Weight lbs	385.12

Features & Materials

Assembly Required	Yes
Burner Grate Material	Stainless-Steel
Number Of Burners	8
Fuel Type	LP
Casters	4
Ignition Type	Pizeo
Certifications	ETL Listed

Plan View

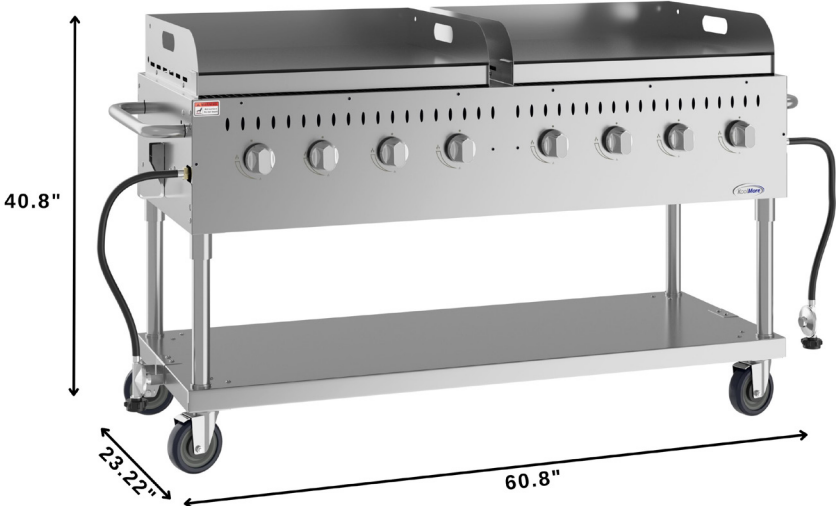

Griddle

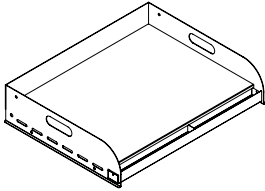
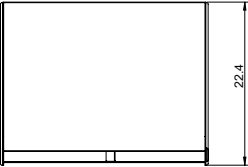
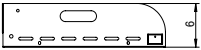
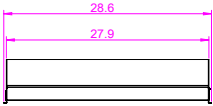

CERTIFICATIONS



Intertek



706 Eastern Parkway STE 1G, Brooklyn NY 11213
718-576-6342
info@koolmore.com