



SPEC SHEET

KoolMore 24 in. Commercial Underbar Ice Bin with Sliding Lid in Stainless Steel

Model: KM-UIB-1824

FEATURES

- Generous Capacity: 77 lbs. of ice storage for peak-hour demands.
- Insulated Sliding Cover: Keeps ice solid longer with excellent temperature control.
- Durable Construction: 304 stainless steel for lasting use in commercial settings.
- Efficient Drainage: 1/2-inch bottom drain for easy water removal and cleaning.
- Superior Insulation: Foamed-in-place polyurethane reduces ice melt and refills.
- Adjustable Feet: Plastic bullet feet ensure stability and level placement.
- Convenient Backsplash: 3-inch design keeps workspace clean and dry.
- Bottle Holders: Includes 2 holders (3 bottles each) for easy access to mixers.
- Galvanized Steel Legs: Corrosion-resistant support for durability and style.
- Easy to Clean: Stainless steel and drainage system simplify maintenance.
- NSF Certified & Warranty: Meets safety standards with a 1-year parts/labor warranty.



CLOSE UP IMAGES



TECHNICAL SPECS

Dimensions

Length	24
Width	18.5
Height	33
Weight Lbs	50.75
Dxwxh Of Bowl1	15x22x12
Backsplash Size	3 In.

Features & Materials

Ice Storage Capacity Lb	77 lbs.
Insulated Cover	Yes
Storage Bin Insulation	Foamed-in-place polyurethane insulation
Gauge Of Stainless Steel	20
Diameter Of Drain Line Connection	.5 In.
Exterior Material	Stainless-Steel 304
Interior Material	Stainless-Steel
Legs Material	Galvanized Steel
Feet Material	Plastic Bullet 1 In. Adjustable
Bottle Holder Included	2
Bottle Capacity	3 per Bottle Holder
Certifications	NSF

Plan View

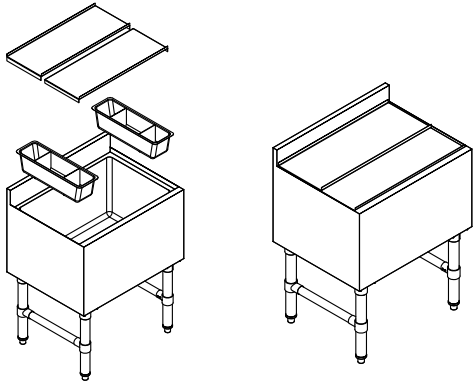
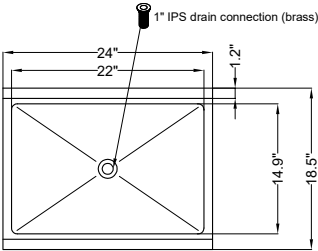
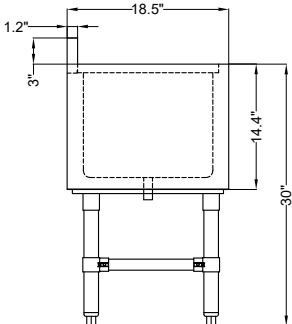
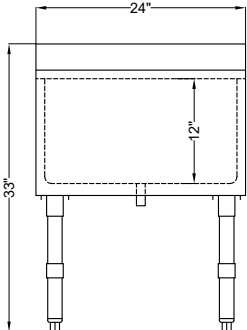

CERTIFICATIONS



706 Eastern Parkway STE 1G, Brooklyn NY 11213
718-576-6342
info@koolmore.com