



# SPEC SHEET

## KoolMore 72 in. 10-Burner Commercial Outdoor Propane Gas Grill with Two 36 in. Roll Dome Covers in Stainless-Steel, ETL Listed

Model: CGKIT7-D36D36

### FEATURES

- Commercial Kitchen Precision: Brings high-performance cooking to outdoor spaces.
- High-Quality Construction: 13-gauge 304 stainless steel resists rust and corrosion.
- Powerful Burners: Ten 16,000 BTU burners, spaced 5.75" apart, ensure even heat.
- Quick Start-Up: Heats to cooking temperature in 5 minutes.
- Spacious Cooking Area: 1377 sq. in. for multiple dishes at once.
- Piezo Ignition System: Reliable, hassle-free startups.
- Mobility: Large casters for easy movement.
- Convenient Accessories: Includes 4 grates, 2 propane hoses, and a side handle.
- Dual Propane Tank Setup: Holders and hoses for two tanks extend cooking time.
- Assembly Required: Straightforward setup with all parts included.
- Stainless Steel Roll Domes: Two 36" 16-gauge 304 stainless steel domes with thermometers, open to 90°.
- ETL Certified & Warranty: Meets safety standards with a 1-year parts/labor warranty

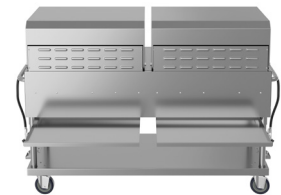
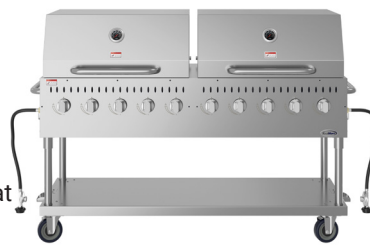

### CLOSE UP IMAGES

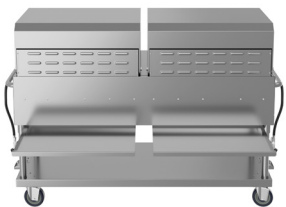

# TECHNICAL SPECS

## Dimensions

Length	72.4
Width	23.22
Height	34.8
Assembled Height	48.6
Weightlbs	242

## Features & Materials

Assembly Required	Yes
Burner Grate Material	Stainless-Steel
Number Of Burners	10
Fuel Type	LP
Casters	4
Ignition Type	Pizeo
Certifications	ETL Listed

# Plan View

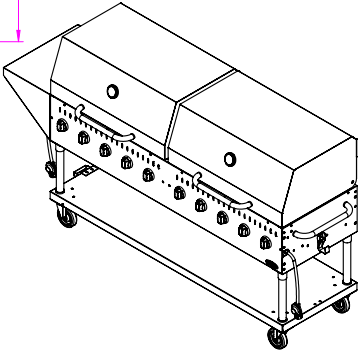
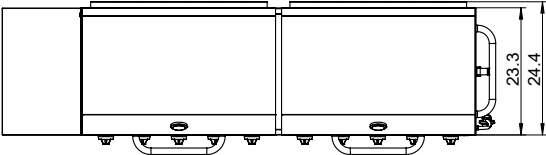
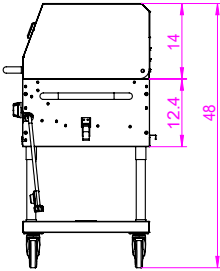
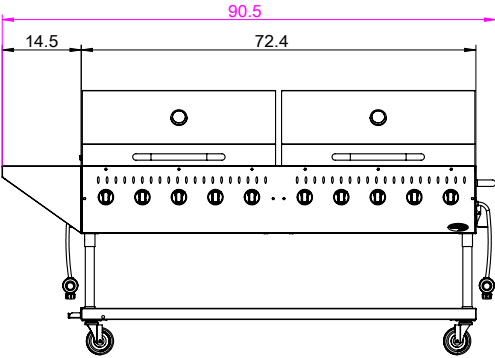

## CERTIFICATIONS



706 Eastern Parkway STE 1G, Brooklyn NY 11213  
718-576-6342  
info@koolmore.com