

ITEM #



ROTATOR Series

Gas/Wood-Fired Oven, Brick, Rotator
RT110WG

Experience a level of quality that is Italian-inspired, but manufactured for the needs of North American restaurants. Marra Forni brick ovens combine traditional artisanal workmanship, such as a full refractory brick enclosure for outstanding performance, with modern manufacturing technology and design innovation. Each oven is hand-made, brick-by-brick, using the same time-proven techniques that masons have used for generations. As functional art for the front of the house, or built into a wall or other structure for ease of cleaning, each oven is completely customizable for specific needs and decors.

Each model features our unique Marra Stone® stone-hearth cooking surface as its heart. This proprietary refractory brick surface includes volcanic material, for outstanding cooking results as well as constant temperatures for consistency. Insulated construction allows heat to be absorbed and retained in the oven cavity for improved efficiency. The oven is operated by a MarraSmart® fully-programmable digital touchscreen controller to maximize thermal control for ideal baking results, over an extended temperature range between 200-950°F (93-510°C).

The Rotator series features a bi-directional rotating Marra Stone® cooking deck with programmable variable speeds. The rotating deck improves operator efficiency and product consistency, while minimizing the need for staff with higher skill sets. Gas primary heat provides efficiency, while a choice of wood or coal auxiliary heat imparts traditional flavor profiles and enhances cooking adjustability.



Standard Features

- MarraStone® stone hearth deck is of a refractory brick that includes volcanic material. This deck is both durable and highly porous, and is capable of maintaining cooking temperatures from 200-950°F (93-510°C) for consistent high-volume production
- MarraSmart® digital touch screen control technology is fully programmable and provides complete control of oven cooking conditions, as well as automatic timed on/off with menu selection and QR code scanning for service and maintenance videos
- Rotating bi-directional cooking deck. Rotation speed is adjusted automatically, with preset program options for consistency of results over a wide range of cooking requirements. Rotation speed may also be adjusted manually from 15-270 seconds per revolution for increased flexibility
- Superior cooking performance and recovery based upon natural convective airflow within the oven chamber, and the heat retention of custom formulated refractory bricks
- Combined forced-air gas and wood-burning heating provides efficiency as well as preserving traditional wood-fired cooking flavors
- Independently-controlled dual gas burners provide redundancy and even heat distribution
- Integrated eyebrow exhaust duct designed into the structure of the oven dome ensures effective capture and exhaust of the oven cavity
- Unique drop-down mantle allows for easy access and cleaning of the oven beneath the cooking deck, and includes 1-1/4" (32mm)-thick black granite ledge
- Removable front door
- Painted matte black steel front facade
- Heavy duty black powder-coated steel stand
- Customizable exterior tile selections
- Manufactured in the U.S.A.

Cooking Capacity (typical)

- 8" (200mm) pizzas: 10
- 10" (250mm) pizzas: 9
- 12" (300mm) pizzas: 8
- 16" (400mm) pizzas: 3

Production capacity varies depending upon type of food product being cooked, food preparation and set temperature.

Total Cooking Surface 10.23 sq. ft. (0.95 sq. m)

Cooking Deck Diameter 43-1/4" (1100mm)

Configuration Options (Check all that apply)

Fuel Type

- Wood-Fired
- Natural Gas
- Liquid Propane Gas

Options

- Direct Ventilation (quoted separately)
- Exhaust Fan with Variable Speed Fan Control
- Integrated Fan Interlock
- Gas Regulator (2 required)
- 4' (1219mm) Quick Disconnect Hose (2 required)
- Spark Arrestor
- Stainless Steel Facade
- Stainless Steel Stand
- Interior Light Box
- Customized Exterior Tile Upgrade
- Base Enclosure (Side Panels)
- Base Enclosure (Full Skirt Enclosure)
- Front-Mounted Landing Table
 - Left
 - Right
 - Both

Accessories

- Dough Tray
- Dough Tray Lid(s)
- Dough Tray Dolly
- Standard Peel Tool Kit
- Deluxe Peel Tool Kit
- Wall Mounted Tool Rack



ANSI Z83.11 | CSA 1.8 | UL 2162 | ULC/ORD C2162 | NSF/ANSI 4

ROTATOR Series
RT110WG

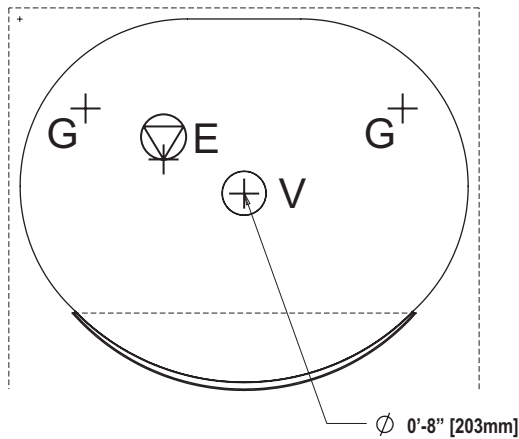
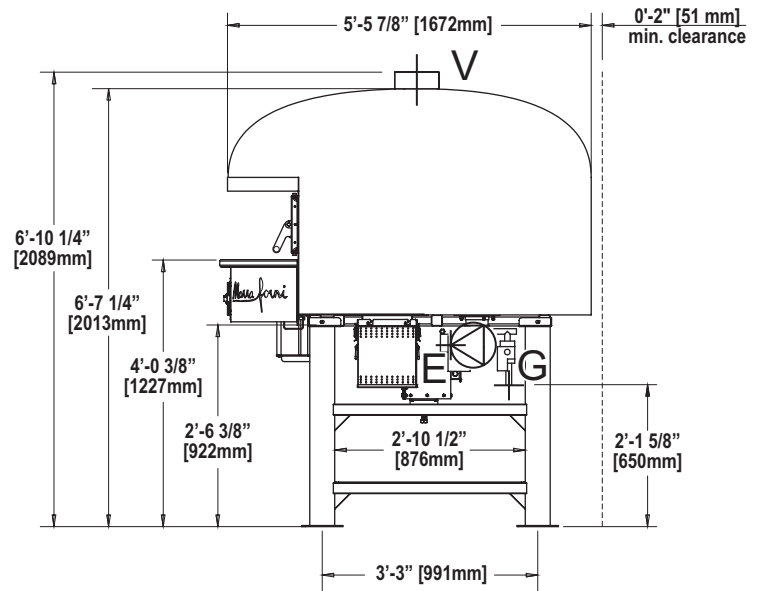
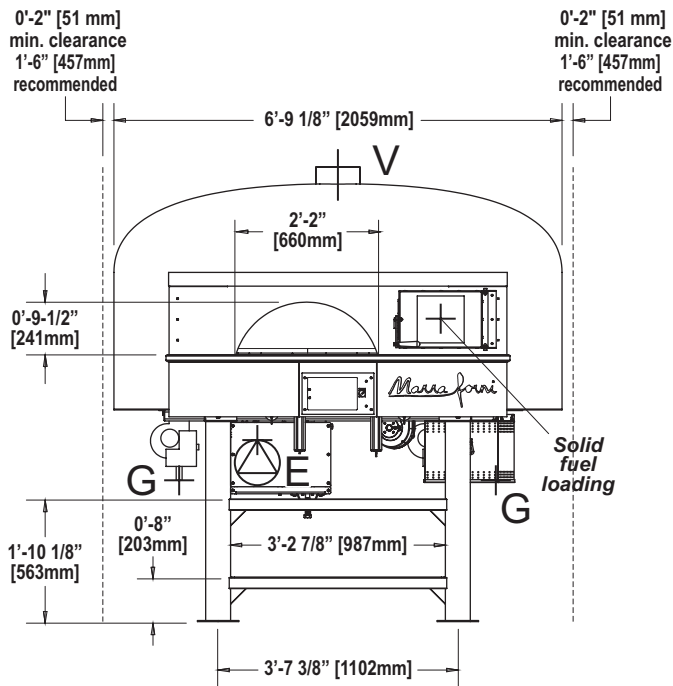

Electrical connection

9' (2.74m) flexible cord with NEMA 5-15P plug provided



Ventilation connection

8" (203mm) dia.



Gas connection (2)

3/4" NPT. Gas-suitable flex hose with quick disconnect required (supplied by others)

Solid fuel loading

Wood

Volume and wood type is dependent on desired flavor profile and baking temperature

For utility loads and connection details, refer to Page 3 of this spec sheet.

All specifications are subject to change without notice, based on Marra Forni's commitment to ongoing product development and improvement measures. Ovens are designed only for the cooking of manufacturer-approved food products in commercial and institutional settings, and should not be used for any other purpose.

ROTATOR Series

RT110WG



Electrical Connection Requirements

Electrical supply	Peak load ampacity	Min. supply ampacity	Max. breaker/disconnect	Plug	Cord
110V 50/60 Hz, 1 Ph	12A	15A	15A	NEMA 5-15P	9' (2.74m)

9' (2.74m) flexible cord with plug provided. Use of a GFCI (ground fault connection interruptor) outlet is not recommended for this appliance. Electronic burner ignition systems may frequently engage such a device and/or suffer from ignition failure as a result. If a GFCI outlet must be used, please consult with the factory for assistance.

Ventilation Connection Requirements

Connection	Volume	Static Pressure
8" (203mm) round collar	150 CFM 255 m ³ h	0.01" W.C. 2.5 Pa

Oven may be installed with an approved direct vent system, or an approved Type 1 exhaust hood system. Ventilation system must comply with all applicable local and national codes.

If direct ventilation is desired, a Marra Forni-designed optional vent system is available as an option and is strongly recommended. This option also requires the exhaust fan (with variable speed fan control) option.

If not using a Marra Forni-supplied direct ventilation connection, determining correct ventilation and code compliance is the responsibility of others.

Gas Connection Requirements

Maximum (per burner)	Minimum (per burner)	Avg./burner over 10 hr. duty cycle (Optional gas regulator reqd.)	Supply connection	
			Natural gas	Propane
145,000 BTU 42.5 kW	70,000 BTU 20.5 kW	84,000 BTU 24.6 kW	3/4" NPT	3/4" NPT
			Orifice diameter	0.173"
			Air shutter gap	1/4" (6.4mm)
			Gas inlet supply pressure	10-14" W.C. (2.5-3.5 kPa)
			Input manifold pressure	10" W.C. (2.5 kPa)
			Output man. pressure, low fire	1.8" W.C. (0.5 kPa)
			Output man. pressure, high fire	5.8" W.C. (1.4 kPa)

Supply via two (2) gas-suitable flex hoses with 3/4" NPT connection and quick disconnects (hoses and disconnects supplied by others). Each of the two (2) burners should be treated as a separate appliance for purposes including gas supply requirements, presence of flow regulators, heat load calculations for the room, and makeup air.

Dimensional Information

- Minimum clearance: 2" (51mm) on all sides and rear from combustible surfaces, 0" (0mm) from non-combustible surfaces, 8" (203mm) below front granite mantle for opening clearance, 18" (450mm) side clearance recommended for service access
- Exterior: (H x W x D): 82-1/4" x 65-7/8" x 67-1/4" (2089 x 2059 x 1672mm)
- Shipping: (H x W x D): 87" x 83" x 73" (2210 x 2108 x 1854mm)
- Weight: 3,900 lbs. (1769 kg)
- Crated Weight: 4,300 lbs. (1950 kg)
- Freight Class: 77.5, shipped LTL

Specification

RT110WG Item # _____

Unit will be an ETL-listed Marra Forni RT110WG freestanding, wood and gas heated rotating deck oven, intended for cooking and baking pizza and other approved food products.

Operating voltage will be 110V, 50/60 Hz, 1 Ph.

Unit heating will be provided by forced-air gas burners and a solid-fuel chamber intended for wood burning. Independently-controlled dual gas burners will be used for redundancy and even heat distribution.

Unit will feature a bi-directional rotating stone hearth cooking deck composed of a refractory brick composition, including volcanic material, to provide and maintain cooking temperatures up to 950°F (510°C).

Unit will feature a programmable electronic controller with selectable menus to accommodate a variety of cooking requirements, automatic timed on/off features, and display of QR codes to access documentation including service and maintenance videos.

Rotation speed of deck is adjusted automatically with preset program selections, or manually from 15-270 seconds per revolution.

Unit cooking area will measure 43-1/4" (1100mm) in diameter. Door opening will measure 26" (660mm) in width and 9-1/2" (241mm) in height.

Unit will feature a brick interior for superior heat retention and distribution within the cooking chamber.

Unit will feature a fully tiled exterior.

Unit will include a removable front door.

Unit will include a drop-down mantle to permit easy cleaning beneath the oven's cooking deck. Mantle will include a 1-1/4" (32mm)-thick black granite ledge.

Unit will include a black powder-coated steel stand and painted matte black steel front facade

Unit will be manufactured in the U.S.A. and comply with all applicable FTC requirements for this status.