

Low Profile Refrigeration

ROYAL SERIES



LS60L-SSS-LR

Standard Features

- 29" High without Top, 30" High with 1" Optional Top
- 24" Front to Back Depth (25" with Top)
- Coved corner stainless steel interior
- Heavy duty self-closing 24"W doors (LS36, LS60, and LS84) and 16"W doors (LS52 and LS72)
- Stainless steel door handles with built-in locks
- Digital thermostat
- Built-in Cool White LED Lighting (7000K)
- DynamicChill 360° Technology
- Includes condensate evaporator pan
- Durable shelves, one floor rack and one adjustable shelf per door
- Approved for NSF 7 Open Food Storage
- Eco-friendly Refrigerant and Insulation
- 5-Year Compressor Warranty
- 2-Year Parts & Labor Warranty

Base Model	Length	Doors	Amps	Bottle Capacity	HP	Weight
LS36	36"	1	1.7	110	1/5	257 lbs.
LS52	52"	2	2.2	165	1/4	270 lbs.
LS60	60"	2	2.2	250	1/4	324 lbs.
LS72	72"	3	2.7	260	1/4	378 lbs.
LS84	84"	3	2.7	395	1/3	432 lbs.

Specifications

Electrical	115 V, 1 Phase, 60 Hz Furnished with 8' plug-in cord, which exits left or right rear of cooler NEMA 5-15P plug configuration Dedicated 15 amp circuit recommended
Refrigeration	R290 Hydrocarbon Refrigerant 30°F - 40°F operating range Digital thermostat on front grille
Plumbing	No drain required Condensate evaporator pan included
Insulation	2" thick foamed-in-place polyurethane
Interior	20 gauge stainless steel walls with coved corners NSF epoxy coated durable shelves - one bottom and two adjustable shelves per door
Exterior	Sides: 20 gauge stainless steel Front: 20 gauge stainless steel Top: 20 gauge stainless steel with option of 1" top
Doors	Self-closing 24"W doors available in black vinyl, stainless steel, glass with black vinyl, or glass with stainless steel 19-3/4"W x 24-11/16" H door opening (LS36, LS60, LS84) 15-3/4"W x 24-11/16" H door opening (LS52 & LS72)

DUAL ZONE TEMPERATURE CONTROL*

Model	Description
RB-STAT	Red Wine, 60°F-65°F and Beer, 30°F-40°F
RW-STAT	Red Wine, 60°F-65°F and White Wine, 50°F-55°F
WB-STAT	White Wine, 45°F-50°F and Beer, 34°F-40°F

*Only available on 60" and 84" units

This equipment is intended for the storage and display of non-potentially hazardous bottle or canned products only.

This equipment is intended for use in an area where the ambient temperature typically does not exceed 75 °F.

Krowne • 100 Haul Rd. Wayne, NJ 07470 • P: (800) 631-0442 • F: (973) 872-1129 • support@krowne.com • krowne.com

Due to our commitment to continued product improvement, specifications are subject to change without notice.

Rev 0 • 2/2026 • No. 1.3C Low Profile Refrigeration



Low Profile Refrigeration

ROYAL SERIES

One Door (36")

Models beginning LS36

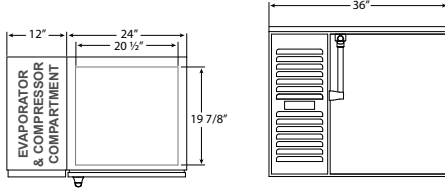

Standard Door Side View

Applies to all Models

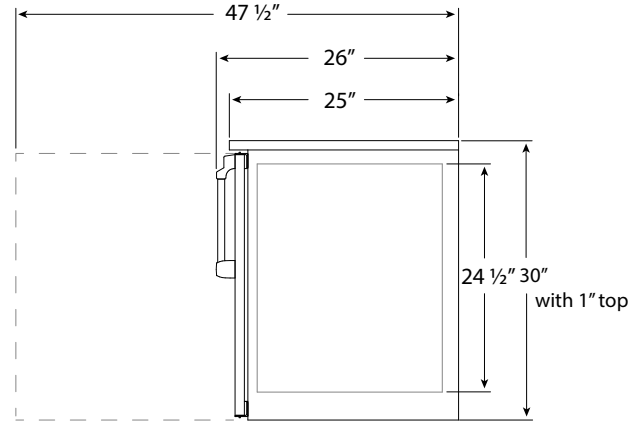

Two Narrow Doors (52")

Models beginning LS52

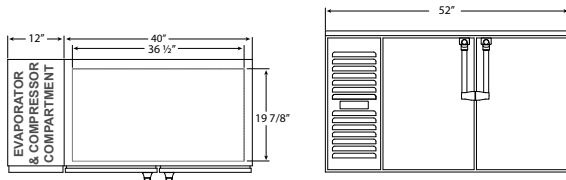

Two Doors (60")

Models beginning LS60

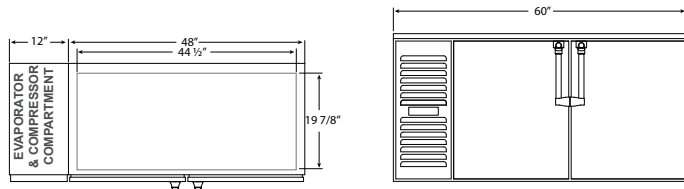

Three Narrow Doors (72")

Models beginning LS72

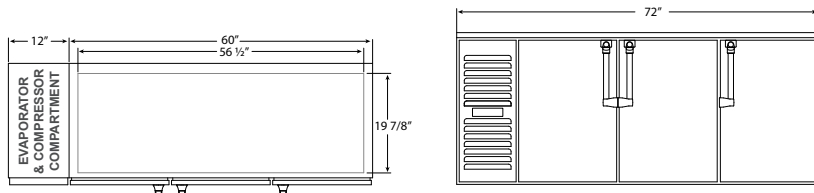

Three Doors (84")

Models beginning LS84

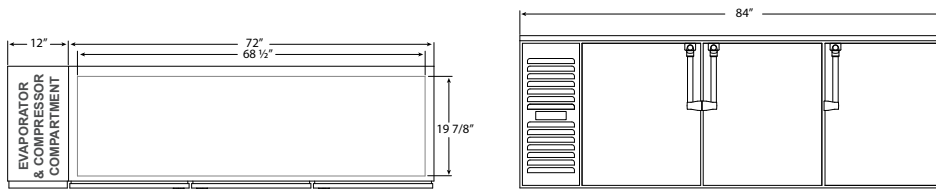

Note: Optional casters raise height 1" higher than wheel size & optional 4" or 6" legs available

