

PLAN VIEW
RIGHT HINGE
SELECT

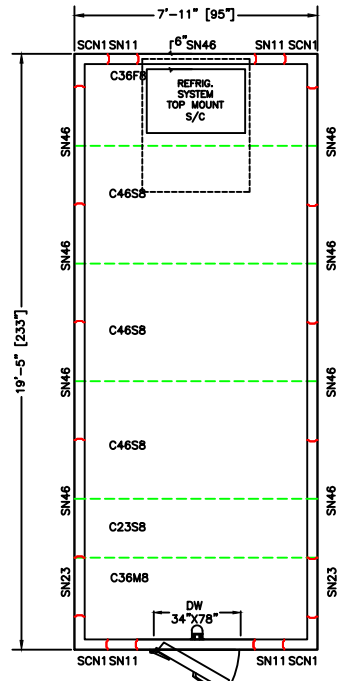

PLAN VIEW
LEFT HINGE
SELECT

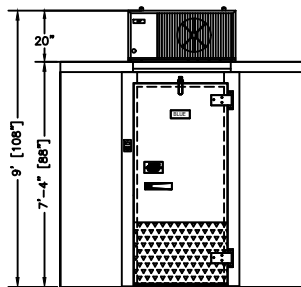

ELEVATION
RIGHT HINGE

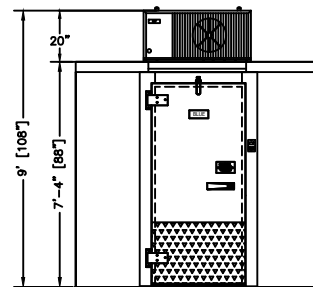

ELEVATION
LEFT HINGE

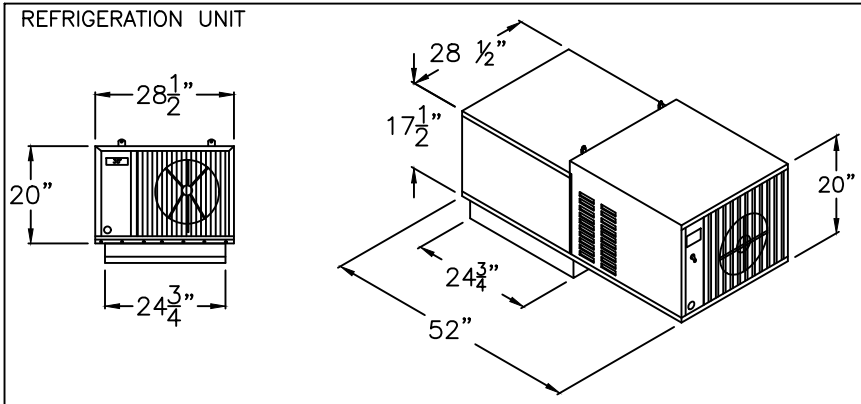

**IMPORTANT: ALLOW 2 FEET CLEARANCE ABOVE UNIT
DO NOT STORE OBJECTS IN FRONT OR THE SIDES OF THE UNIT.
FOLLOW OEM'S CLEARANCE GUIDELINES TO ENSURE PROPER OPERATION**

REFRIGERATION DESIGN SPECIFICATIONS	
WALK-IN AMBIENT TEMP:	90°F
CONDENSER AMBIENT TEMP:	95°F
PULLDOWN:	24 Hours
HOLDING TEMP:	35°F
OPENINGS PER HOUR:	2

PRODUCT SPECIFICATIONS	
MODEL:	BL820-C-SC
WALK-IN SPECIFICATIONS	
INTERIOR/EXTERIOR FINISH	26 GAUGE MILL EMBOSSED ACRYLUME OR 26 GAUGE STUCCO EMBOSSED GALVANIZED STEEL
ELECTRICAL (VOLTS/Hz/PH)	115/60/1
MAX AMP.	0.8
REFRIGERATION SYSTEM SPECIFICATIONS	
ELECTRICAL (VOLTS/Hz/PH)	208-230/60/1
AMPS	12.3
WEIGHT (LBS)	260
MATCHING NEMA RECEPTACLE	6-20R
WALK-IN AND REFRIGERATION FREIGHT	
TOTAL SHIPPING WEIGHT (LBS)	2248
MAXIMUM PALLET SIZE	48" X 96" X 102" HIGH
NUMBERS OF PALLETS	2

MODEL: BL820-C-SC
 INDOOR-NO FLOOR
 COOLER 35°F
 SELF CONTAINED REFRIGERATION

CUSTOMER APPROVAL
 DATE: _____
 SIGNATURE: _____

CONFIDENTIAL
 THE DRAWINGS, TECHNICAL DATA, AND ALL OTHER INFORMATION SET FORTH IN THIS DOCUMENT COMPRISE TRADE SECRETS AND CONFIDENTIAL INFORMATION THAT IS THE EXCLUSIVE PROPERTY OF ARCTIC INDUSTRIES, LLC.
 USE OF SUCH INFORMATION IS LIMITED TO THE PURPOSE FOR WHICH IT WAS PROVIDED AND NO RECIPIENT IS PERMITTED TO USE, COPY, OR DISCLOSE SUCH INFORMATION EXCEPT AS EXPRESSLY AUTHORIZED BY ARCTIC INDUSTRIES, LLC.