



STANDARD FEATURES

- Molded heat-insulated tank coated by stainless steel
- Static refrigeration with coil into the plane + upper static evaporator in polish tube
- Thermostatic valve
- Stainless steel trays in polished finished
- Tempered glass box
- Back glass sliding doors
- LED lighting
- Digital control panel
- LCD temperature display

SUSHI DISPLAY (SQUARE GLASS)						
MODELS	LENGTHS	DEPTH	HEIGHT	WEIGHTS (LBS)	VOLTAGES	AMPS
SHSQ1000	39 3/8" (1000mm)	15 3/4" (400mm)	10 13/16" (275mm)	110lbs	120V	1A
SHSQ1000T*	52 1/4" (1326mm)	15 3/4" (400mm)	10 13/16" (275mm)	135lbs	120V	4A
SHSQ1250	49 1/4" (1250mm)	15 3/4" (400mm)	10 13/16" (275mm)	135lbs	120V	1.5A
SHSQ1250T*	62 1/16" (1576mm)	15 3/4" (400mm)	10 13/16" (275mm)	170lbs	120V	5A
SHSQ1500	59 1/16" (1500mm)	15 3/4" (400mm)	10 13/16" (275mm)	175lbs	120V	2.1A
SHSQ1500T*	71 15/16" (1826mm)	15 3/4" (400mm)	10 13/16" (275mm)	210lbs	120V	6A
SHSQ2000	78 3/4" (2000mm)	15 3/4" (400mm)	10 13/16" (275mm)	245lbs	120V	3A
SHSQ2000T*	91 9/16" (2326mm)	15 3/4" (400mm)	10 13/16" (275mm)	280lbs	120V	6A

* T = SELF CONTAINED

* Manufacturer reserves the right to change specifications without notice. Not responsible for error and omissions.



361-367 Beach Road, Burlingame, CA 94010
 Tel: 855.885.2400 | 650.342.2400 | Fax: 650.342.7400
 sales@oscartek.com | www.oscartek.com



SHSQ SERIES FRONT COUNTERS

SUSHI DISPLAY SQUARE GLASS

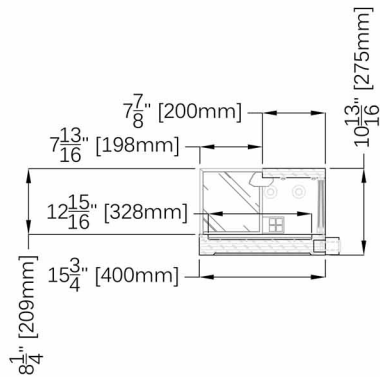

SHSQ1000

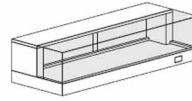

SHSQ1250



SHSQ1500



SHSQ2000

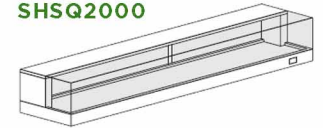

PLAN VIEWS

REMOTE:

SHSQ1000

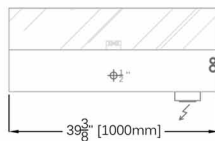

SHSQ1250

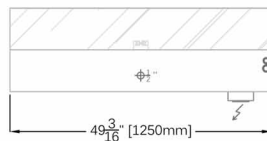

SHSQ1500

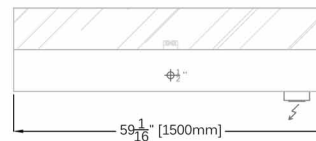

SHSQ2000

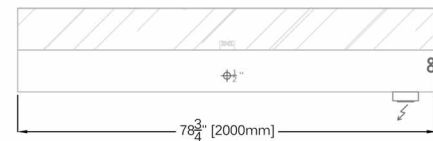

SELF-CONTAINED:

SHSQ1000T

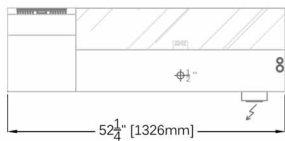

SHSQ1250T

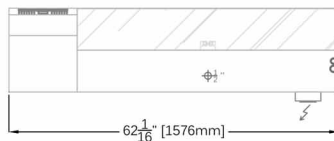

SHSQ1500T

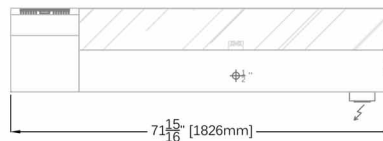

SHSQ2000T

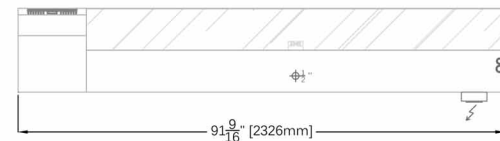

REAR ELEVATIONS (OPERATOR SIDE)

REMOTE:

SHSQ1000

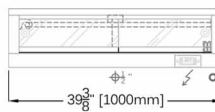

SHSQ1250

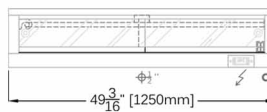

SHSQ1500

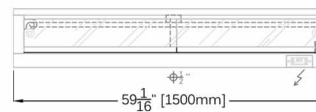

SHSQ2000

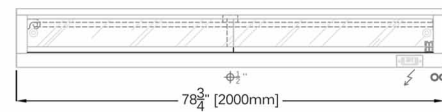

SELF-CONTAINED:

SHSQ1000T

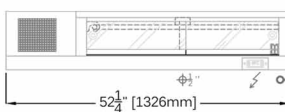

SHSQ1250T

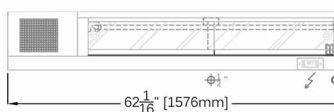

SHSQ1500T

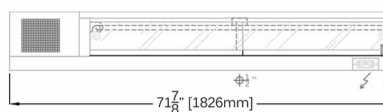

SHSQ2000T



* Manufacturer reserves the right to change specifications without notice. Not responsible for error and omissions.



361-367 Beach Road, Burlingame, CA 94010
 Tel: 855.885.2400 | 650.342.2400 | Fax: 650.342.7400
 sales@oscartek.com | www.oscartek.com

