



KM-2200SRJZ3

3 PHASE STACKABLE ICE CUBER



KM-2200SRJZ3
02/03/22
Item # 13659

W x D x H
48" x 27^{3/8}" x 36^{7/16}"

KM Edge
DESIGN

KM-2200SRJZ3 ★
Remote Air-Cooled 3 Phase
Shown on optional bin: B-900





Item #: _____
Project: _____
Qty: _____
AIA#: _____

Features

▶ Individual crescent cube

▶ Stainless steel evaporator

▶ CycleSaver™ design 

- Up to 2206 lbs. of ice production per 24 hours
- Stackable for 4412 lbs. per 24 hours ice production in the same floor space
- Durable stainless steel exterior
- Protected by H-Guard Plus Antimicrobial Agent 
- EverCheck™ alert system 
- R-404A Refrigerant

Available on Bins:

B-800SF B-1150SS B-1500SS *Top kit may be required.*
B-900SF B-1300SS B-1650SS *See Bin Spec Sheets.*

Warranty:

Valid in United States, Canada, Puerto Rico and U.S. Territories. Contact factory for warranty in other countries.

Shipping: (LxWxH) 51.75" x 33" X 42.5" Volume: 42.00ft³

Condenser	Model	ICE PRODUCTION		WATER USAGE		ELECTRICAL					Refrigerant Charge Amount	Net / Ship Weight (lbs.)	
		Air / Water Temp Lbs. per 24 hours 70° / 50°F 90° / 70°F		Potable Gal. per 100 lbs. 90° / 70°F	Condenser Gal. per 100 lbs. 90° / 70°F	kWh Used per 100 lbs. 90° / 70°F	Max. Fuse Sz or HACR Circuit Bkr	Amperage	Voltage	Circuit Wires (including ground)			Heat Rejection BTU/hr.
3 Phase Remote	KM-2200SRJZ3	2206	2075	15.0	N/A	3.75	20A	15.9A	208-230V/60/3	4	26,700	8 lbs. 6 oz. 16 lbs. 1.5 oz.†	390 / 400

† (with condenser)

KM Edge Cube Dimensions*

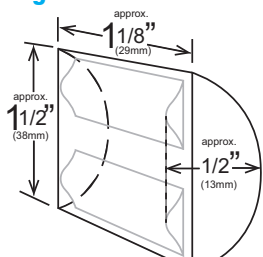

* approximate size in inches, image not to scale

Operating Limits

- Ambient Temp Range 45 - 100°F
- Water Temp Range 45 - 90°F
- Water Pressure 10 - 113 PSIG
- Voltage Range 187 - 253V

Service

- Panels easily removed and all components accessible for service.
- Allow 6" (15 cm) clearance at rear, sides, and top for proper air circulation and ease of maintenance/service.

Plumbing

- Icemaker Water Supply Line: Min. 3/8" Nominal ID Copper Water Tubing or Equivalent
- Icemaker Drain Line: Min. 3/4" Nominal ID Hard Pipe or Equivalent

Water Filter

Please refer to water filter spec sheet for recommended configurations.

Hoshizaki reserves the right to change specifications without notice.



KM-2200SRJZ3

3 PHASE STACKABLE ICE CUBER

KM-2200SRJZ3

02/03/22

Item # 13659

FRONT VIEW

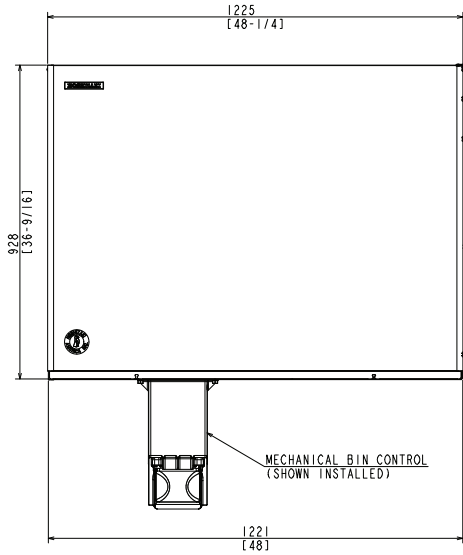

SIDE VIEW

Front
→

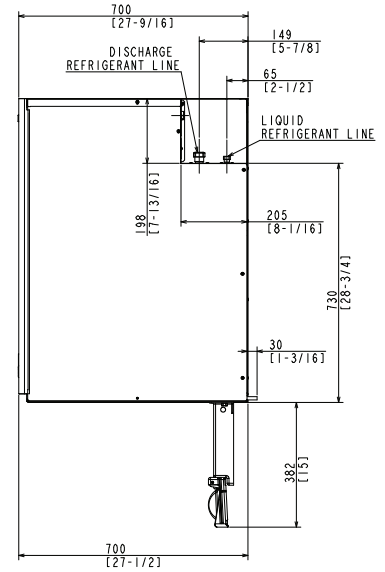

REAR VIEW

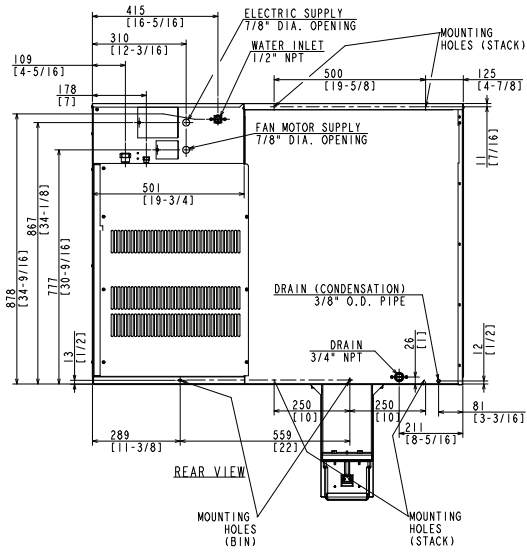

BOTTOM VIEW

Front
↓

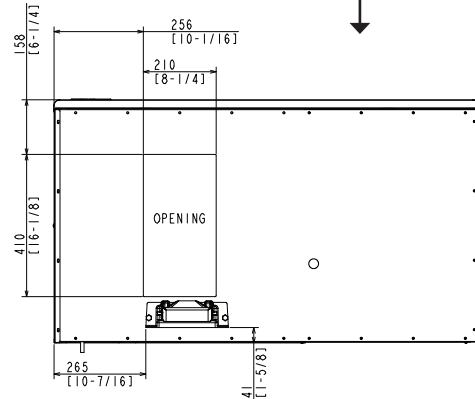

URC-22FZ Remote Condenser (Sold Separately)

(W x D x H) 46 3/8 X 14 1/16 X 40 1/2
For Use with KM-2200SRJZ3

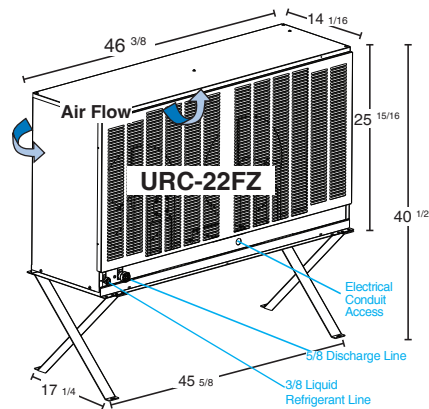

Brazed Line Sets

(Sold Separately)

25' HS-5323

35' HS-5324

55' HS-5325



Voltage supply for the URC Remote Condenser is supplied from the Ice Maker. No additional circuit is required.