

## QUICK SHIP

### Walk-In Coolers & Freezers With Matching Refrigeration Systems



#### FEATURES

- Unlimited lengths in 1' increments
- Available in widths of 6', 7', 8', 9', 10', 11' & 12'
- Heights: 6'7", 7'7" and 8'7" with floor, 7'4" and 8'4" floorless for single compartment and combinations
- Heights: 7'7" and 8'7" combination with floor freezers and less floor coolers with 4-3/8" foam sealers
- Indoor or outdoor models
- Available with Split-Pak™ remote refrigeration systems or Capsule Pak™ self-contained systems (systems ordered separately; Capsule Pak systems applicable to single compartment walk-ins under 14' in length)
- Temperatures: +37°F, -10°F
- Full 4" thick panels foamed-in-place with EPA-compliant polyurethane insulation
- 26 gauge corrosion resistant stucco embossed coated steel on all surfaces except interior floor
- Smooth aluminum interior floor (models with floor)
- Floorless models supplied with NSF listed vinyl sealers
- 26", 30" or 36" wide self-closing doors
- Deadbolt locking handle with independent key/padlock feature and inside safety release
- Two heavy duty cam-lift hinges per door, top hinge field adjustable with locking set screw
- Spring loaded hinge
- Spring actuated door closer
- Magnetic gasket
- Combination digital thermometer and light switch
- Floor double sweep gasket
- Perimeter door heater wire
- Heated air vents standard in freezer door sections
- High output low profile LED light positioned above door to prevent interference with shelving or product
- NSF listed, UL flame spread 25 or less for all foam cores on all panels; UL electrical listing on door sections
- UL & C-UL electrical listing on refrigeration systems\*
- UL NCKL listed certifying walk-ins are ignition protected
- City of Houston listed
- CN UL flame spread listed
- California State listed
- Oregon State listed
- USDA accepted
- 15 year panel warranty
- 18 months parts and labor warranty

#### OPTIONS

(Most options available two weeks from receipt of order. Please contact us for specific questions.)

- Outdoor membrane roof systems
- Door rain hoods
- Interior and/or exterior 30" high stainless steel or aluminum diamond tread door kick plates
- Exterior ramp for floor models
- Interior ramps (30" & 36" wide) for floor models
- Leak detector/alarm (may be a requirement in some areas)
- Extra LED lights (shipped loose)
- Strip curtains (shipped loose)
- Non-skid floor strips (shipped loose)
- Shelving systems
- 1-5/8" screed for use with 5/8" tile after walk-in installation
- 14" x 24" viewport

\* C-UL is Underwriters Laboratories Safety Certification Mark which indicates that UL has tested the equipment to applicable CSA Standards.

**WALK-IN SPECIFICATIONS**

Quick Ship walk-ins are built of modular panels, and are insulated with foamed-in-place EPA-compliant polyurethane insulation. Each panel is designed to ensure ease of installation, long term reliability and high insulating efficiency.

A. All panels are manufactured with male and female mating rails to ensure proper alignment during installation. The polyurethane insulation wraps around the return bend metal seams on both sections to create a lightweight panel of exceptional strength and durability. All panels are a full (4) inches thick and provide a superior insulating value.

**Insulation:**

Panels to be four (4) inches thick, metal clad and foamed-in-place with EPA-compliant polyurethane insulation.

The R-values for 4" HFO panels are:

- Cooler:
  - Walls/Ceilings.....R-value 25
  - Doors.....R-value 25
- Freezer:
  - Walls/Ceilings.....R-value 32
  - Doors.....R-value 32
  - Floors.....R-value 28

B. The foamed-in-place cam locking fasteners ensure an airtight seal for maximum energy efficiency.

C. Quick Ship panel gaskets around the outer perimeter of the panel are continuous, without cuts or breaks at corners. The patented gasket design provides a foamed-in-place gasket as an integral part of the panel. Gaskets cannot fall off or pull off during shipment or installation.

D. Panels lock together tightly to assure an energy efficient walk-in.

E. Edge caps for ends of floor and ceiling panels are foamed-in-place rather than overlapped or mechanically fastened. Edge caps cannot come loose, and they stay in place through the life of the walk-in.

F. Panel Finishes: Interior and exterior complete to be 26 gauge corrosion resistant stucco embossed coated steel. Models supplied with a floor will include a smooth aluminum interior floor surface.

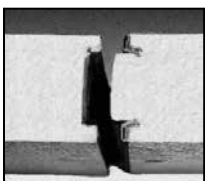

A.

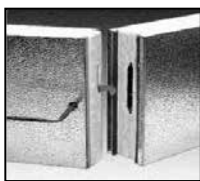

B.

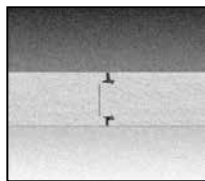

C.

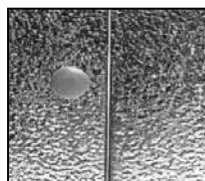

D.



E.

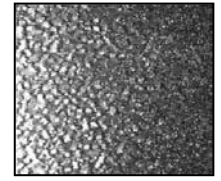

F.

**Quick Ship Walk-ins Available in Both Single Compartment Walk-ins or Cooler/Freezer Combinations**

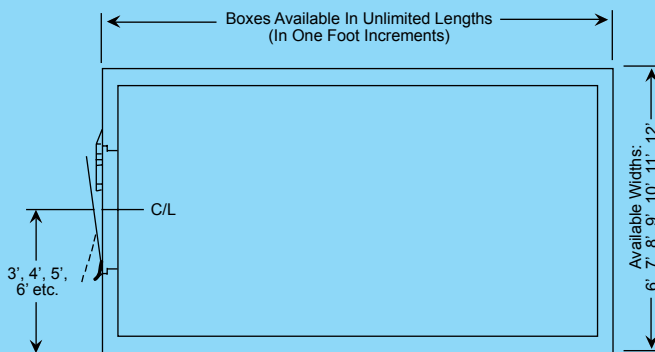

Note: The Walk-In Door Can Be Located On Any Wall.

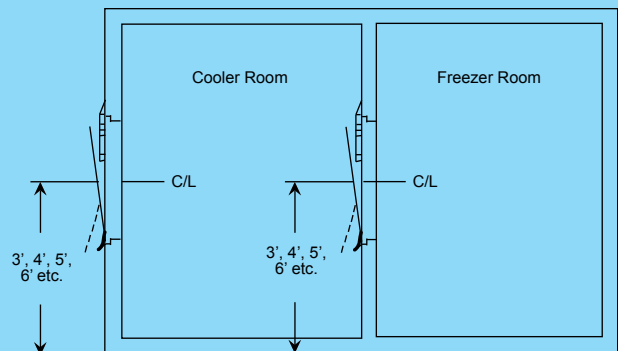

Note: The Partition Door Must Open Into The 35° Compartment.

**DOOR**

Door sections are factory tested to assure proper fit, performance and alignment. All doors feature a stepped profile design that serves as a barrier to air flow which results in an energy efficient door system.

Each Quick Ship Remote walk-in compartment is equipped with a 26", 30" or 36" wide door opening. The height of the door opening varies with the series of Quick Ship walk-in ordered. The 45 Series has a 59" high door, the Standard Series (6'7" high) has a 66" high door opening and the 74 and 77 Series Quick Ship walk-ins have a 78" high door opening. The door is self-closing, flush mounted, infitting and constructed to incorporate heavy duty, molded ABS breaker which is permanently foamed-in-place.

Doors are available with right or left side hinges and include two field adjustable cam-lift hinges with locking set screw, top hinge spring loaded, spring actuated door closer, NL9800 deadbolt locking handle with independent key/padlock feature and inside safety release. The doors are pre-hung in a four foot wide frame panel which is equipped with replaceable perimeter heater wire, magnetic stainless steel trim, digital thermometer, above door LED light fixture and switch with exterior pilot indicator light.

The door section is completely pre-wired within concealed conduit inside the door frame panel. 120/60/1 electrical is field wired to a junction box which is surface mounted on the interior frame above the LED light fixture. Door sections are 4" thick, metal clad and foamed-in-place with EPA-compliant polyurethane insulation.

Hinges and door handle are mounted to 1/2" synthetic insulated tapping plates. Each door section is complete with a fiberglass reinforced plastic heated threshold.

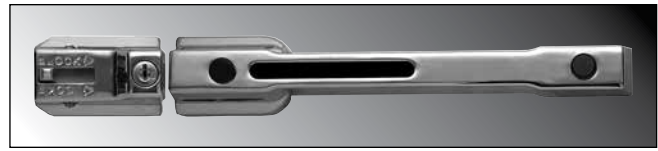

**Deadbolt-locking handle**



**Spring actuated door closer**



**LED light fixture**

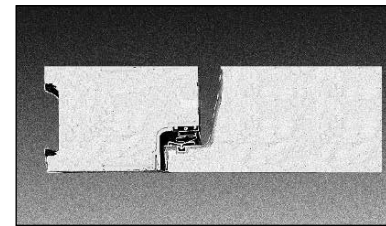

**Doors feature a stepped profile design**



**Digital thermometer/light switch**

**Doors designed and certified for use in walk-in cooler applications**

DOOR MODEL NUMBER	ENERGY CONSUMPTION (KWH/DAY)	DOOR SURFACE AREA (SQ. FT.)	ELECTRICAL	WATTS	AMPS
QS26X59	2.30	12.00	120/60/1	97.73	0.81
QS26X66	2.37	13.40	120/60/1	100.80	0.84
QS26X78	2.49	15.80	120/60/1	106.07	0.88
QS30X66	2.46	15.27	120/60/1	102.56	0.85
QS30X78	2.60	18.00	120/60/1	107.80	0.90
QS36X66	2.60	18.06	120/60/1	105.20	0.88
QS36X78	2.76	21.29	120/60/1	110.50	0.92

**Doors designed and certified for use in walk-in freezer applications**

DOOR MODEL NUMBER	ENERGY CONSUMPTION (KWH/DAY)	DOOR SURFACE AREA (SQ. FT.)	ELECTRICAL	WATTS	AMPS
QS26X59	6.48	12.00	120/60/1	189.69	1.58
QS26X66	6.68	13.40	120/60/1	196.07	1.63
QS26X78	7.01	15.80	120/60/1	207.07	1.73
QS30X66	6.94	15.27	120/60/1	199.75	1.66
QS30X78	7.32	18.00	120/60/1	210.80	1.76
QS36X66	7.33	18.06	120/60/1	205.25	1.71
QS36X78	7.78	21.29	120/60/1	216.30	1.80

## FLOOR CONSTRUCTION

Floor panels (when supplied) are similar in construction to the wall panels except they are made to withstand uniformly distributed floor loads of up to 800 pounds per square foot. The interior floor metal is smooth aluminum.

The 74 Series floorless models are supplied with a patented vinyl floor sealer to stop conductivity at floor level. This unique sealer sits flat on existing floors and fits tightly against the interior/exterior wall panels. The walk-in wall panel is supported on the shoulder of the sealer so the foam edge is free of compressing weight. The vinyl floor sealer is NSF listed.



Floorless models are supplied with a patented vinyl floor sealer

## SPLIT-PAK™ REMOTE REFRIGERATION SYSTEMS

Energy efficient EC motors are standard on Split-Pak evaporator coils.

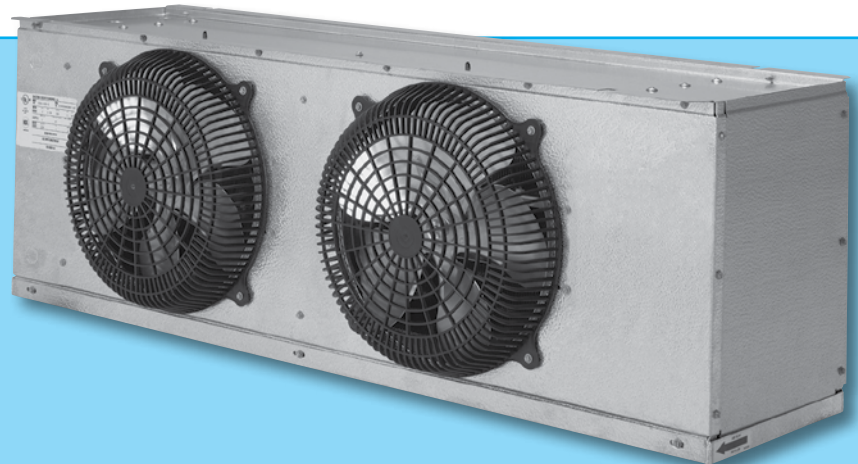
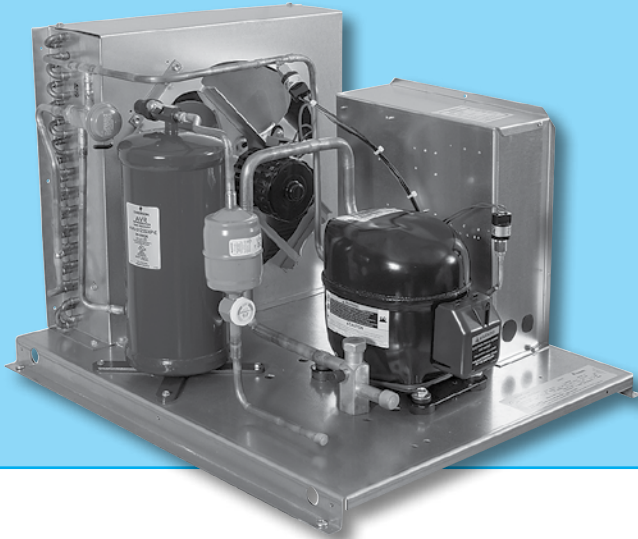

Split-Pak condensing units are standard with generously-sized condensers for maximum performance in harsh environments. Each unit is pre-piped and pre-wired at the factory for convenient installation.

- Split-Pak systems feature condensing unit and evaporator coil sized to fit requirements
- All components are pre-wired and factory assembled on a galvanized steel angle leg base
- Horsepower ranges from 1/2 to 6 H.P.
- Condensing units are provided with factory pre-mounted and wired time clocks in both medium and low temp versions
- Evaporator coils are ready to mount in position and are available in air (off cycle) defrost for coolers and electric defrost for freezers
- Each coil is also furnished with a pre-installed expansion valve and room thermostat mounted and wired
- Electric defrost coils feature defrost termination-fan delay controls and drain line heaters
- Standard energy efficient EC motors



## SPLIT-PAK™ REMOTE REFRIGERATION SYSTEM SPECIFICATIONS

Remote refrigeration systems available for this program are limited to the Split-Pak™ condensing units and evaporator coils on pp. 5-6 only. Condensing units are factory pre-wired and pre-assembled.

All units are provided with matching evaporator coils.

Remote 2 H.P. through 6 H.P. units are available with either one (1) or two (2) matching evaporator coils.

Remote 1/2 and 3/4 H.P. units are available in 230 volt, 60 cycle, one phase only. Units ranging from 1 to 4 H.P. are available in 230 volt, 60 cycle, one phase or 208/220 volt, 60 cycle, three phase. Five and 6 H.P. units are available in 208/220 volt, 60 cycle, three phase only.

Remote condensing units under this program will be provided with weather kits containing a weather hood with unit base and a low ambient kit.

## MEDIUM TEMP R-448A/R-449A CONDENSING UNITS

(Dedicated medium temp outdoor condensing units meet the DOE requirement of a minimum AWEF rating of 7.61 Btu/W-h).

COND. UNIT MODEL*	H.P.	COMPRESSOR MODEL	BTUH @ 25°F SUCTION TEMP. 90°F AMBIENT	UNIT CONNECTION SIZES		BASE SIZE†	RECEIVER PUMP DOWN CAP. @ 90%	SHIP WT. (LB/KG)	MCA**	MOP**	RLA**	LRA**
				LIQUID	SUCTION							
<b>HERMETIC</b>												
MHMD005AB	0.5	RST45C1E-CAV	5,701	3/8	5/8	M1	8.1	180/82	18.8	20	4.6	26.5
MHMD007AB	0.75	RST55C1E-CAV	6,958	3/8	5/8	M1	8.1	180/82	18.8	20	6.1	33.7
MHMD010AB	1	RST70C1E-PFV	8,658	3/8	7/8	M1	8.1	180/82	18.8	20	6.9	46
MHMD010AC	1	RST70C1E-TA5	8,975	3/8	7/8	M1	8.1	180/82	18.8	20	4.9	36
<b>SCROLL</b>												
MSMD015AB	1.5	ZS11KAE-PFV	12,768	1/2	7/8	M2	12	240/109	25	30	11.3	55
MSMD015AC	1.5	ZS11KAE-TF5	12,884	1/2	7/8	M2	12	240/109	19.1	20	9.3	58
MSMD017AB	1.75	ZS13KAE-PFV	14,330	1/2	7/8	M2	12	240/109	25	30	10.8	56
MSMD017AC	1.75	ZS13KAE-TF5	14,469	1/2	7/8	M2	12	240/109	18.8	20	8.7	58
MSMD020AB	2	ZS15KAE-PFV	16,884	1/2	7/8	M2	12	240/109	31.3	35	14.1	68
MSMD020AC	2	ZS15KAE-TF5	17,060	1/2	7/8	M2	12	240/109	25	30	9.6	58
MSMD025AB	2.5	ZS19KAE-PFV	19,376	1/2	7/8	M2	12	240/109	31.8	35	16.2	75
MSMD025AC	2.5	ZS19KAE-TF5	19,353	1/2	7/8	M2	12	240/109	31.3	35	12.3	73

## LOW TEMP R-448A/R-449A SCROLL CONDENSING UNITS

COND. UNIT MODEL*	H.P.	COMPRESSOR MODEL	BTUH @ -20°F SUCTION TEMP. 90°F AMBIENT	UNIT CONNECTION SIZES		BASE SIZE†	RECEIVER PUMP DOWN CAP. @ 90%	SHIP WT. (LB/KG)	MCA**	MOP**	RLA**	LRA**
				LIQUID	SUCTION							
MSLD010AB	1	ZF03KAE-PFV	2,949	3/8	7/8	M1	8.1	180/82	12.5	15	6.1	42.3
MSLD010AC	1	ZF03KAE-TF5	2,921	3/8	7/8	M1	8.1	180/82	9.1	15	4.1	31.7
MSLD020AB	2	ZF06K4E-PFV	7,164	3/8	7/8	M2	12	240/109	25	30	13.6	61
MSLD020AC	2	ZF06K4E-TF5	6,793	3/8	7/8	M2	12	240/109	18.8	20	8.3	55
MSLD025AB	2.5	ZF08K4E-PFV	8,946	3/8	7/8	M3	17.7	250/114	32.6	35	16.4	73
MSLD025AC	2.5	ZF08K4E-TF5	8,699	3/8	7/8	M3	17.7	250/114	25	30	8.7	63
MSLD035AB	3.5	ZF11K4E-PFV	11,759	3/8	7/8	M3	17.7	250/114	38	45	20.7	109
MSLD035AC	3.5	ZF11K4E-TF5	11,958	3/8	7/8	M3	17.7	250/114	31.3	35	10.9	88
MSLD050AC	5	ZF15K4E-TF5	17,523	1/2	7/8	M5	17.7	250/114	38	40	17	123

**NOTES:**

- 448A/449A compressors are shipped with P.O.E. oil.
- All "M" units include low ambient kit (crankcase heater, head pressure control valve) as standard feature.

**\*VOLTAGE KEY:**

"B" suffix = 208-230 or 230 volt, 60 cycle, one phase

"C" suffix = 200-230 or 208-230 volt, 60 cycle, three phase

†See p. 7 for unit base drawings.

\*\*Electrical ratings for condensing unit only. See National Electrical Code if units are combined on a single circuit.

**SPLIT-PAK™ REMOTE REFRIGERATION SYSTEM EVAPORATOR COIL SPECIFICATIONS**

Each coil is furnished with a pre-installed expansion valve and room thermostat mounted and wired

**MEDIUM TEMP**

EVAPORATOR MODEL	UNIT PART NO.	BTUH @ 25°F SUCTION TEMP.	NO. FANS	DIMENSIONS			SHIP WT. (LB/KG)	FAN AMPS
				L	W	H		
E1MD0060A-TA2	WL6A052SEAS	6,000	1	27	16	17	44/20	.8
E1MD0078A-TA2	WL6A066SEAS	7,800	1	27	16	17	47/21	0.8
E1MD0085A-TA2	WL6A073SEAS	8,500	2	44	16	17	52/24	1.6
E1MD0109A-TA2	WL6A094SEAS	10,900	2	44	16	17	55/25	1.6
E1MD0136A-TA2	WL6A117SEAS	13,600	2	44	16	17	58/26	1.6
E1MD0163A-TA2	WL6A141SEAS	16,300	3	60	16	17	72/33	2.4

**LOW TEMP**

EVAPORATOR MODEL	UNIT PART NO.	BTUH @ 25°F SUCTION TEMP.	NO. FANS	DIMENSIONS			SHIP WT. (LB/KG)	FAN AMPS	DEFROST AMPS
				L	W	H			
E1LD0049B-TE2	WL6E042DEAS	4,900	1	27	16	17	44/20	0.5	4.9
E1LD0076B-TE2	WL6E066DEAS	7,600	2	44	16	17	52/24	1	9.8
E1LD0088B-TE2	WL6E077DEAS	8,800	2	44	16	17	55/25	1	9.8
E1LD0106B-TE2	WL6E090DEAS	10,600	2	44	16	17	58/26	1	9.8
E1LD0124B-TE2	WL6E105DEAS	12,400	2	44	16	17	62/28	1	9.8

**NOTES:**

- Medium temp evaporator coils based on 12° T.D. Low temp coils based on 10° T.D.
- VOLTAGE KEY:  
 "A" suffix = 115 volt, 60 cycle, one phase  
 "B" suffix = 208-230 volt, 60 cycle, one phase

**SPLIT PAK™ REMOTE CONDENSING UNIT BASE SPECIFICATIONS**

**BASE "M1"**



**BASE "M2"**

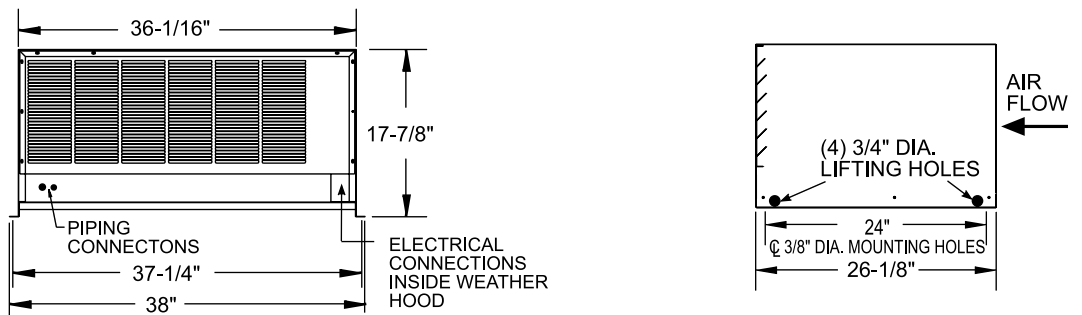

**BASE "M3"**

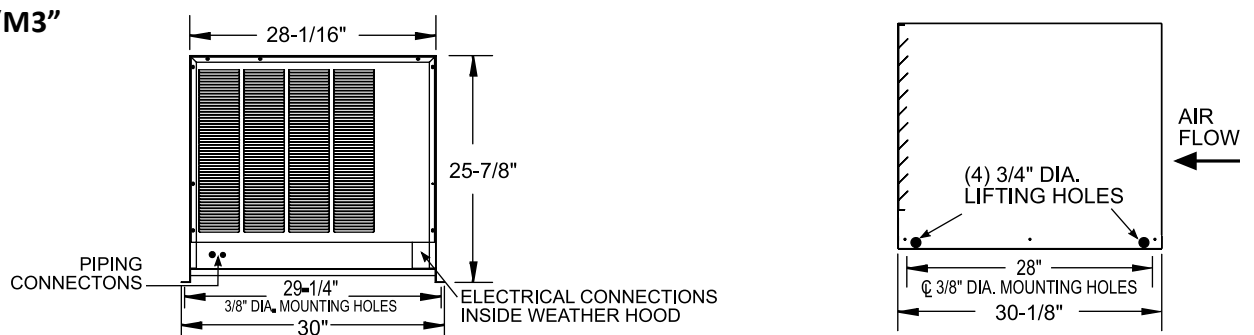

**BASE "M5"**

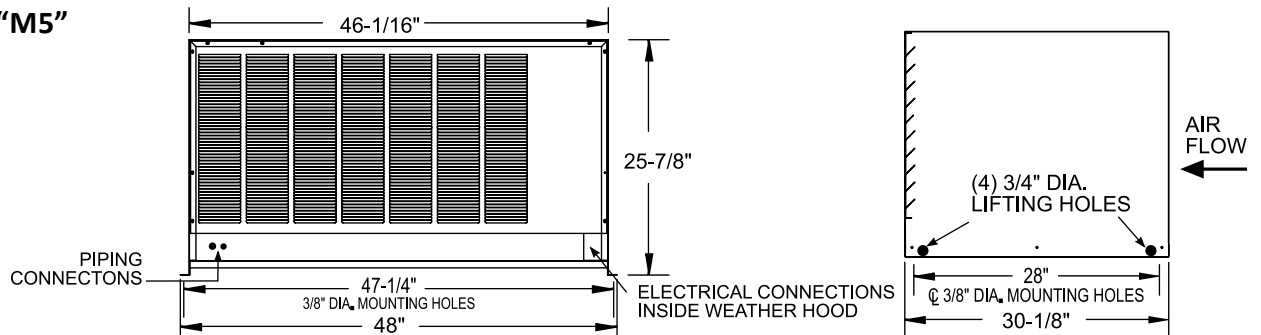

**CAPSULE PAK™ & CAPSULE PAK ECO™ SELF-CONTAINED REFRIGERATION SYSTEMS**

FOR USE IN SINGLE COMPARTMENT WALK-INS UNDER 14' IN LENGTH ONLY

**CHOOSE FROM THESE SYSTEM OPTIONS**

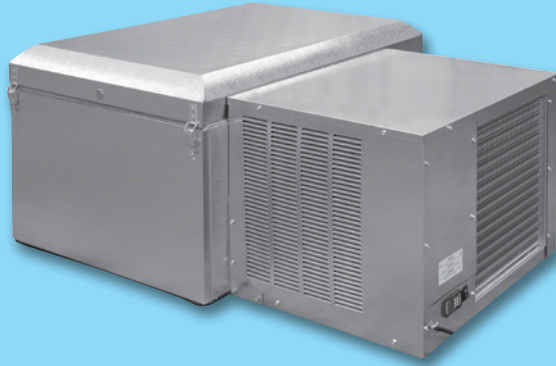

**CAPSULE PAK™  
WITH R449A REFRIGERANT  
INDOOR & OUTDOOR MODELS**

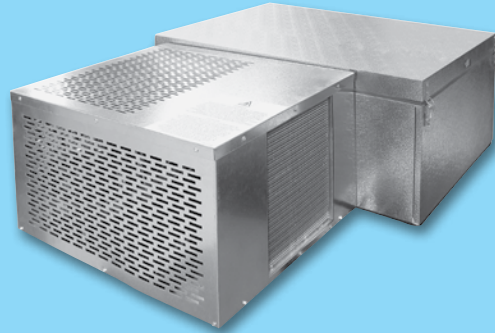

**CAPSULE PAK ECO™  
WITH R290 NATURAL REFRIGERANT  
INDOOR MODELS ONLY**

FEATURE	CAPSULE PAK	CAPSULE PAK ECO
Factory assembled, wired, charged, tested and ready to mount in walk-in ceiling	✓	✓
Indoor and outdoor models	✓	Indoor Only
Available for coolers (+37°F) or freezers (-10°F)	✓	✓
Flush mounted evaporator coil in the walk-in ceiling panel for maximum interior storage space	✓	✓
Standard 115V cord and plug eliminating the need for field electrical connection	✓	✓
Pre-charged with refrigerant eliminating the need for field refrigeration connection	✓	✓
Designed to operate in ambient temperatures up to 100°F	✓	✓
Air cooled condensing unit	✓	✓
LogiTemp™ electronic controller system provides increased reliability, connectivity and food safety	✓	✓
Automatic condensate evaporator (indoor models only)	✓	✓
Electronic control provided for automatic defrost on both coolers and freezers	✓	✓
UL and C-UL electrical listing on complete Capsule Pak refrigeration systems*	✓	✓
AWEF compliant	✓	✓
DOE, CARB and SNAP compliant	✓	✓
-20°F ambient controls (outdoor models)	✓	⊗
Systems for outdoor walk-ins contain a crankcase heater and head master	✓	⊗
18 months parts and labor warranty	✓	✓
Patent pending design	⊗	✓
Optional heater kit for outdoor use with medium temp applications where ambient conditions may go below 32°F	✓	⊗
Optional electric vaporizer (indoor models only)	✓	✓
Optional condensing unit air deflection kit	✓	✓
Optional 5 year compressor warranty	✓	✓

\* C-UL is Underwriters Laboratories Safety Certification Mark which indicates that UL has tested the equipment to applicable CSA Standards.



**CAPSULE PAK™ & CAPSULE PAK ECO™ SELF-CONTAINED REFRIGERATION SYSTEM SPECIFICATIONS**

Capsule Pak™ and Capsule Pak ECO™ refrigeration systems consist of a single assembly pre-charged condensing unit and evaporator coil factory assembled, wired, tested and ready for insertion into a factory prepared walk-in ceiling opening.

Capsule Pak and Capsule Pak ECO systems are ceiling mount. A flush evaporator coil keeps all components outside the walk-in storage area allowing more storage inside. Capsule Pak models are available for indoor or outdoor installations while Capsule Pak ECO systems are indoor only. Models are available for interior compartment design temperatures of +35°F and -10°F. Installation is fast and easy with no plumbing required on indoor units.

The evaporator section is designed to be located entirely outside the walk-in with no intrusions into the refrigerated space. The evaporator enclosure is constructed utilizing foamed-in-place polyurethane insulation and equipped with a removable, gasketed access cover. High efficiency EC evaporator fan motors circulate air throughout the walk-in.

Indoor Capsule Pak models are equipped with either a discharge gas condensate vaporizer or an optional electric condensate vaporizer. Outdoor Capsule Pak models are equipped with low ambient controls consisting of crankcase heater and flooded condenser head pressure control. Capsule Pak ECO models incorporate a condensate pan with wicking pads and forced air from the condenser fan to evaporate condensate.

Capsule Pak and Capsule Pak ECO systems are UL and C-UL listed and DOE compliant. Note: Allow minimum of 4" clearance above and 24" on each side of the system for installation. Consideration should be given to accessibility for service and free condenser air flow. Consult factory with installation questions.

**STANDARD LOGITEMP™ ELECTRONIC CONTROLLER ON ALL CAPSULE PAK & CAPSULE PAK ECO SYSTEMS**

- More precise and reliable temperature control compared to all-mechanical systems
- Digital readout and four button overlay for easy setup and navigation
- Demand Defrost technology that initiates defrosts only as needed for further energy savings (Capsule Pak only)
- LogiTemp provides online data for instant notification of error codes and settings (Capsule Pak only)

**CAPSULE PAK™ & CAPSULE PAK ECO™ REFRIGERATION SYSTEMS PHYSICAL SPECIFICATIONS**

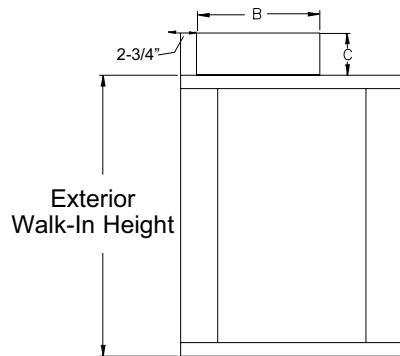

Side View

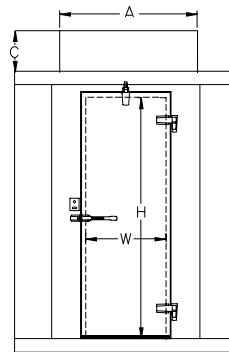

Front View

DOOR OPENING SIZE		
W	H	MODEL
26"	66"	STD Series
26"	78"	74 Series
26"	78"	77 Series

CAPSULE PAK™ MODEL NO.	"A"	"B"	"C"
CPB050JC-*0-EV	41-1/8"	50-1/2"	20-5/8"
CPB075JC-*4-EV	41-1/8"	50-1/2"	20-5/8"
CPB100JC-*4-EV	41-1/8"	50-1/2"	20-5/8"
CPF060JC-*4-EV	41-1/8"	50-1/2"	20-5/8"
CPF075JC-*4-EV	41-1/8"	50-1/2"	20-5/8"
CPF100JC-*4-EV	41-1/8"	50-1/2"	20-5/8"
CPF150JC-*4-EV	45-3/4"	53-3/8"	24-3/4"
CPF200JC-*4-EV	45-3/4"	53-3/8"	24-3/4"

CAPSULE PAK ECO™ MODEL NO.	"A"	"B"	"C"
CPB050PC-S-0	36-3/4"	48-1/4"	14-7/8"
CPB075PC-S-0	36-3/4"	48-1/4"	14-7/8"
CPB100PC-S-0	36-3/4"	48-1/4"	18-7/8"
CPF050PC-S-0	36-3/4"	48-1/4"	14-7/8"
CPF075PC-S-0	36-3/4"	48-1/4"	14-7/8"
CPF100PC-S-0	36-3/4"	48-1/4"	18-7/8"
CPF150PC-S-4	36-3/4"	48-1/4"	18-7/8"

\* Insert "S" for indoor model and "E" for outdoor

NOTE:

- Consideration must be given to accessibility for service & free condenser air flow. Consult factory with installation questions. Proper condensing unit ventilation must be provided. The factory recommends 200cfm of fresh air in the surrounding area with ample clearance around the condensing unit.
- +90°F ambient or less and 50% RH
- Subject to change without notice

**CAPSULE PAK™ & CAPSULE PAK ECO™ REFRIGERATION SYSTEMS ELECTRICAL DATA**
**CAPSULE PAK™ INDOOR REFRIGERATION SYSTEMS (CORD AND PLUG CONNECTED)**

MODEL	REFRIGERANT	ELECTRICAL	TOTAL SYSTEM AMPS	TOTAL DEFROST AMPS	NEMA PLUG	AWEF	BTUH*
CPB050JC-S-0-EV	R-449A	115/60/1	9.3	N/A	5-15P	5.61	4400
CPB075JC-S-4-EV	R-449A	208-230/60/1	5.5	N/A	6-15P	5.61	6366
CPB100JC-S-4-EV	R-449A	208-230/60/1	7.5	N/A	6-15P	5.61	7300
CPF060JC-S-4-EV	R-449A	208-230/60/1	8.0	5.7	6-15P	1.99	2250
CPF075JC-S-4-EV	R-449A	208-230/60/1	8.5	5.7	6-15P	2.08	3130
CPF100JC-S-4-EV	R-449A	208-230/60/1	9.6	5.7	6-15P	2.11	3500
CPF150JC-S-4-EV	R-449A	208-230/60/1	11.1	8.7	6-15P	2.22	4509
CPF200JC-S-4-EV	R-449A	208-230/60/1	15.7	8.7	6-20P	2.43	6725

**CAPSULE PAK OUTDOOR REFRIGERATION SYSTEMS (CORD AND PLUG CONNECTED)**

MODEL	REFRIGERANT	ELECTRICAL	TOTAL SYSTEM AMPS	TOTAL DEFROST AMPS	NEMA PLUG	AWEF	BTUH*
CPB050JC-E-0-EV	R-449A	115/60/1	9.3	N/A	5-15P	7.60	4115
CPB075JC-E-4-EV	R-449A	208-230/60/1	5.5	N/A	6-15P	7.60	5802
CPB100JC-E-4-EV	R-449A	208-230/60/1	7.5	N/A	6-15P	7.60	6884
CPF060JC-E-4-EV	R-449A	208-230/60/1	8.0	5.7	6-15P	2.89	2135
CPF075JC-E-4-EV	R-449A	208-230/60/1	8.5	5.7	6-15P	2.92	2875
CPF100JC-E-4-EV	R-449A	208-230/60/1	9.6	5.7	6-15P	2.95	3210
CPF150JC-E-4-EV	R-449A	208-230/60/1	11.1	8.7	6-20P	3.03	4362
CPF200JC-E-4-EV	R-449A	208-230/60/1	15.7	8.7	6-20P	3.15	6350

**CAPSULE PAK ECO™ INDOOR REFRIGERATION SYSTEMS (CORD AND PLUG CONNECTED)**

MODEL	REFRIGERANT	ELECTRICAL	TOTAL SYSTEM AMPS	TOTAL DEFROST AMPS	NEMA PLUG	AWEF	BTUH*
CPB050PC-S-0	R290	115/60/1	6.9	N/A	5-15P	5.61	4100
CPB075PC-S-0	R290	115/60/1	11.4	N/A	6-20P	5.61	6700
CPB100PC-S-0	R290	115/60/1	15.3	N/A	6-20P	5.61	8800
CPF050PC-S-0	R290	115/60/1	9.4	9.4	5-15P	1.96	1600
CPF075PC-S-0	R290	115/60/1	11.4	11.4	6-20P	2.07	2900
CPF100PC-S-0	R290	115/60/1	15.3	15.3	6-20P	2.18	4000
CPF150PC-S-4	R290	230/60/1	TBD	TBD	6-20P	TBD	TBD

\*BTUH calculated using 16 hour design runtimes on coolers and 20 hour design runtimes on freezers

**Note:**

- Consult factory for application specifics, pricing and ship date availabilities.
- All self-contained Capsule Pak systems require a single power supply.



Capsule Pak Models

9 ft. long power cord  
attached to condensing  
unit section

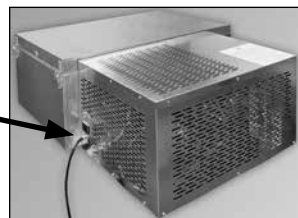

Capsule Pak ECO Models

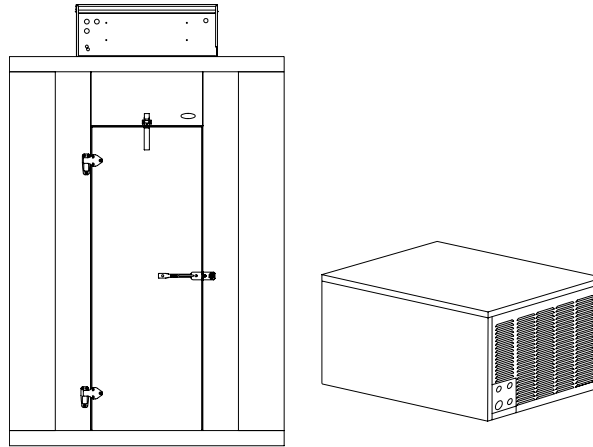
**REMOTE CAPSULE PAK™ SYSTEMS (ALL WITH R-449A REFRIGERANT)****Optional Electric Condensate Vaporizer**

Remote Capsule Pak Systems are available with an electric condensate vaporizer. This UL and C-UL approved product requires no drain lines on indoor applications, which makes installation fast and easy and allows equipment to be operational in a shorter time frame.

**NOTE: All specifications within this publication subject to change without notice.**