



PROJECT	
ITEM #	
QUANTITY	DATE
APPROVAL	

KCU & KCU-NU

Mobile Beverage Counters

Short Form Specifications

Exterior Body is seamless, one-piece molded fiberglass, having perfectly smooth exterior surface with all corners fully rounded. The fiberglass reinforced polyester (F.R.P.) is molded with permanent color. Stress points are internally reinforced.

Exterior top is constructed of 14-gauge stainless steel, welded, ground and polished into one integral unit. Top is fabricated with square exterior corners. Top is reinforced and includes a stainless steel drain trough with a removable stainless steel anti-splash drip gate. Drain trough has a 1" (2.5cm) I.P.S. drain plumbed to a drain valve located at the right bottom of the unit. Drain trough is located on the customer's side of counter top.

Casters; unit is mounted on 5" (12.7cm) diameter swivel casters with non-marking polyolefin tires and plate brakes. Overall height of caster assembly is 6" (15.2cm).

The following applies to SCU Series only

KCU units have a single door dry compartment constructed of 18-gauge stainless steel. Compartment is equipped with stainless steel shelf. Doors are double-wall construction, with stainless steel front panel. Mechanical access door available upon request.

KCU-36 one compartment, 24" wide with one door
KCU-50, one compartment, 36" wide with two doors
KCU-60, one compartment, 48" wide with two doors
KCU-74, one compartment, 48" wide with two doors
KCU-96, two compartments, 36" wide with two doors each

Optional Accessories and Modifications

- A) 12" (30.5cm) wide stainless steel fold-down tray slide
 - C) 10" (25.4cm) wide three-bar fold-down tray slide
 - D) 10" (25.4cm) wide composite fold-down cutting boards
 - E) 10" (25.4cm) wide stainless steel fold-down work shelf
 - F) Line-up interlock device
 - FF) Dual service drain troughs
 - P) Open understorage with shelf (KCU-NU Series only)
 - Q) * 120V/60Hz/1ø, 10 amp convenience outlet with breaker
 - SG5A) Single dry insert with doors (KCU-NU Series only)
 - SG5B) Double dry insert with doors (KCU-NU Series only)
 - ST) Stainless steel trim strips
 - U) 14" x 30" (35.6cm x 76.2cm) stainless steel end drop shelf
 - UU) Molded fiberglass trim strips
 - V) 6" (15.2cm) high adjustable stainless steel legs in lieu of casters
- *Inclusion of this options will alter the electrical specifications of unit.*



Model KCU-50-NU
(pictured with optional legs)



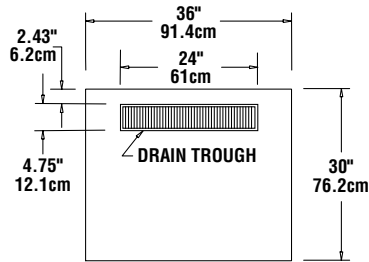

**PLAN VIEW
KCU-36/
KCU-36-NU**

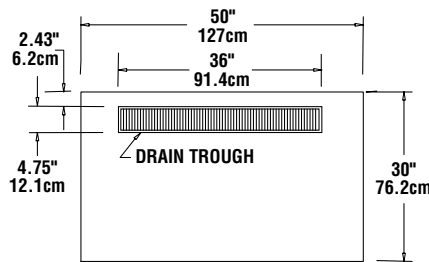

**PLAN VIEW
KCU-50/
KCU-50-NU**

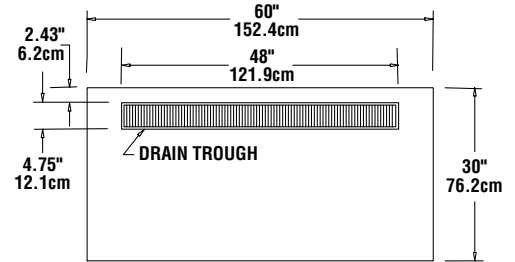

**PLAN VIEW
KCU-60/
KCU-60-NU**

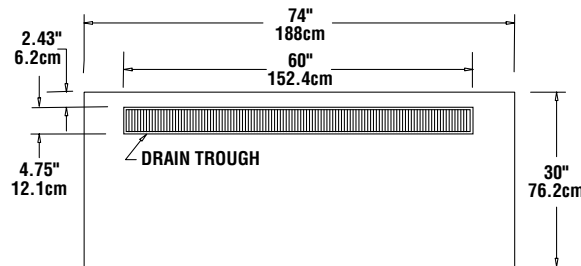

**PLAN VIEW
KCU-74/
KCU-74-NU**

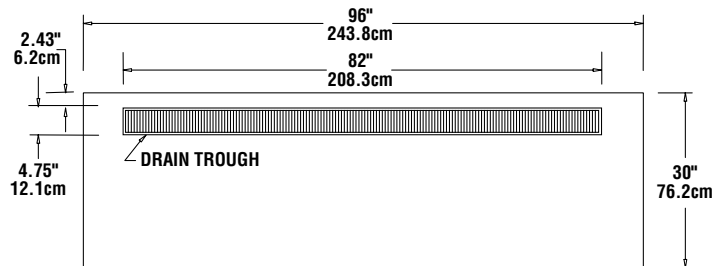

**PLAN VIEW
KCU-96/
KCU-96-NU**

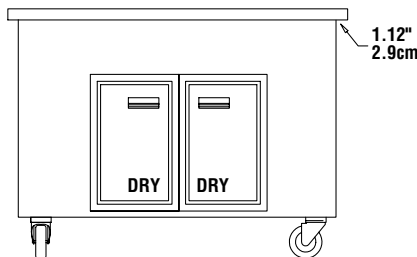

**ELEVATION VIEW
ALL KCU-50/KCU-74 MODELS
(KCU-96 two 36" compartments
not shown)**

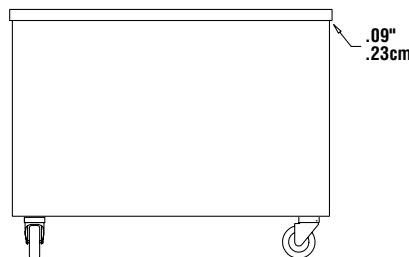

**ELEVATION VIEW
ALL KCU-NU MODELS**

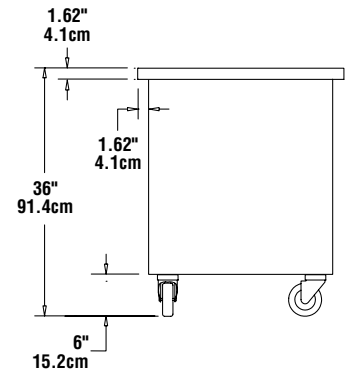

**END VIEW
ALL MODELS**

Mechanical Data—Standard Unit

MODEL NUMBER	# OF DOORS	# OF SHELVES	SHIP WEIGHT	MODEL NUMBER	SHIP WEIGHT
KCU-36	2	1	200 lbs/91 kg	KCU-36-NU	170 lbs/77 kg
KCU-50	2	1	230 lbs/104 kg	KCU-50-NU	190 lbs/86 kg
KCU-60	2	1	270 lbs/123 kg	KCU-60-NU	230 lbs/104 kg
KCU-74	2	1	300 lbs/136 kg	KCU-74-NU	260 lbs/118 kg
KCU-96	4	2	340 lbs/154 kg	KCU-96-NU	300 lbs/136 kg