

# GIORIK

INNOVATIVE COOKING EQUIPMENT SINCE 1963

## Steambox EVOLUTION H

# SEHE062W

Combi Electric Oven - 6 GN 2/1

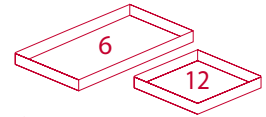
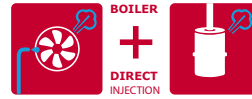

6 full-size sheet pans  
12 half-size pans, or 12 steam table pans



Giorik Steambox Evolution is the high-end level combi oven that provides maximum flexibility using dry heat, moist heat, or any other combination thanks to the patented high efficiency Symbiotic Steam System.

The Giorik Symbiotic Steam System combines a traditional boilerless system with a high efficiency microboiler to create large volumes of steam on demand - all while using 30% less water and 20% less energy versus traditional boiler systems.

The moisture level of steam is ensured by the patented SteamTuner System. This system determines both QUALITY and QUANTITY of steam in the cooking chamber adjusting the hydration level of steam from very wet to very dry depending on user choice.

The Meteo System allows Steambox Evolution to constantly monitor the climate inside the cooking chamber and quickly take action to maintain the proper degree of humidity.

The Steambox Evolution comes standard with a 9" Touch Screen Control and hundreds of preset cooking programs with a full array of menu selections. Each cooking program can have up to 9 phases that can be adjusted depending on user experience.

Standard 2 year parts & labor warranty.

## steamtuner

Steambox Evolution is fitted with a patented system that makes it possible to adjust the moisture level in the steam, thereby setting the right degree of dryness or wetness for the required cooking.

## Meteo SYSTEM

To guarantee a perfectly balanced climate inside the cooking chamber, Giorik has patented a unique humidity control system (Meteo System) using software that analyzes the relevant parameters in the cooking chamber and then regulates the production of steam or discharges excess humidity.

## RecipeTuner

The RecipeTuner interface makes it possible to modify and personalize the various programs simply and intuitively. According to the type of cooking selected, a food product's cooking, browning, degree of rising and degree of humidity can be easily modify..

## EasyService

level control cooking

The Rack Control enables different dishes to be cooked at the same time at various levels. What's more, with EasyService, a Rack Control function, all the dishes can be served at the same time.

## TECHNICAL FEATURES

- Steam production with Symbiotic System (patented)
- SteamTuner (patented) for tuning dry-wet steam
- Meteo System (patented) for humidity control in the cooking chamber
- Large 9" Touch Screen Control
- Ability to store over 1000 menu items
- Heating of cooking chambers with high performance INCOLOY heating elements
- High efficiency boiler with automatic descaling
- AISI 304 cooking chamber with rounded corners
- Automatic recirculating washing system (tablets or liquids)
- LED lighting
- Rapid chamber ventilation system
- Inverter-controlled fan with 6 different speeds
- Safety shutdown of fan rotation by opening the door
- Double-glazed ventilated door
- USB port for uploading & saving recipes and for firmware updating

## COOKING FEATURES

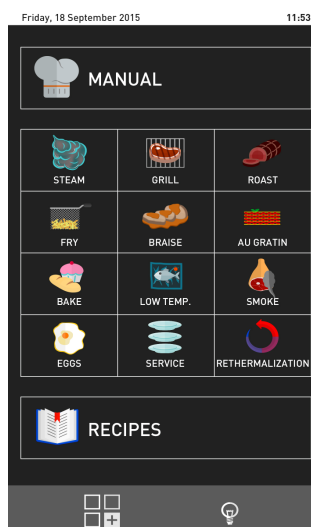

- Cooking modes: convection, steam, combi (convection & steam)
- Cooking by method or product type
- Temperature control from 86° to 572°F
- Time control from 1' to 599'; infinite function
- Humidity Control from 0-100%
- SteamTuner: dry or wet steam
- Delta T cooking
- Cooking with probe
- Multi level cooking with "Easy service"

# SEHE062W

Combi Electric Oven - 6 GN 2/1

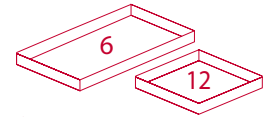
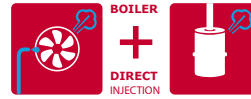

6 full-size sheet pans  
12 half-size pans, or 12 steam table pans

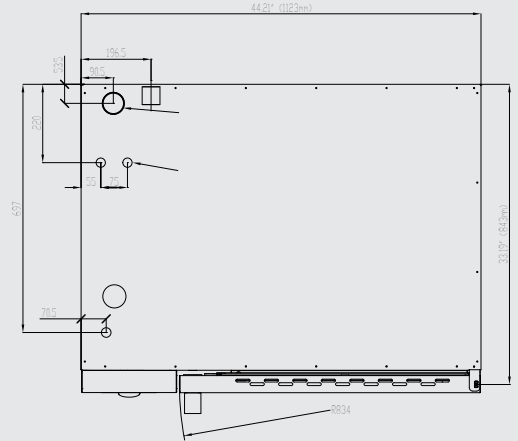
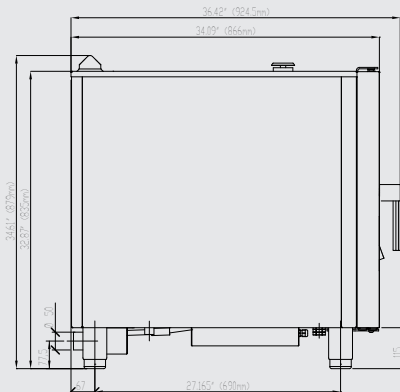
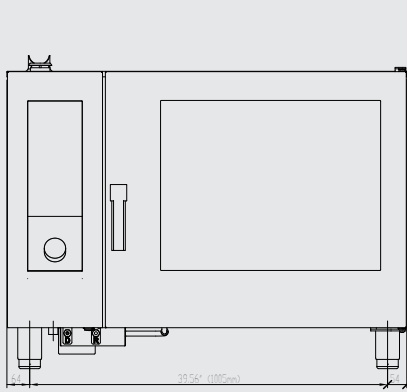

### REQUIRED CLEARANCES

LEFT	0"-20" (508mm) for service
RIGHT	0"
FRONT	32.88" (834mm) for door swing
BACK	3" (75mm) for plumbing

### DIMENSION

	HEIGHT	WIDTH	DEPTH	WEIGHT
<b>Uncrated</b>	34.61" (879mm)	44.21" (1123mm)	36.42" (925mm)	386lb (176kg)
<b>Crated</b>	40.25" (1022mm)	45.5" (1156mm)	38.5" (978mm)	430lb (195kg)

### ELECTRICAL OPTIONS (Cord & plug not included)

Volts	Phase	Cycle/Hz	kW	Amps	Wires
208	3	60	21.2	62	3+Grnd
480	3	60	21.4	27	3+Grnd

### WATER REQUIREMENTS

**NOTE: Not maintaining Giorik water quality requirements voids warranty**

Pressure (min-max): 35 • 87 PSI
Hardness (CaCO3) = Between 30-90 mg/L (Milligrams per Liter or ppm)
TDS (Total Dissolved Solids)= Between 40-150 mg/L (Milligrams per Liter or ppm)
Free Chlorine = Less than 0.1 mg/L (Milligrams per Liter or ppm)
Chlorides = Less than 20 mg/L (Milligrams per Liter or ppm)
Chloramines = Less than 0.5 mg/L (Milligrams per Liter or ppm)
Total Sulfates & Nitrates = Less than 20 mg/L (Milligrams per Liter or ppm)
Total Silica = Less than 10mg/L (Milligrams per Liter or ppm)
Total Iron = Less than 0.1mg/L (Milligrams per Liter or ppm)
pH level = 7.0 to 8.0

### PAN CAPACITY

12 ea. 12" x 20" x 2.5" (65mm) Steam table pans

12 ea. 13" x 18" half size sheet pan

6 ea. 18" x 26" full size sheet pan

### CONNECTIONS

3/4" GHT cold water inlet

3/4" GHT treated water for cooking as per Giorik water requirements

2" (50mm) drain

### OPTIONS and ACCESSORIES

Stands	Reversible doors (consult with factory about additional width considerations)
Stacking system	Culinary components
Cooking Probes	Drain Lock
Tablet detergent and rinse aid	

**Giorik US Corporation**

400 Birnie Street, Suite D  
Greenville, SC 29611 - US

1-833-446-7451

[www.giorikus.com](http://www.giorikus.com)

Rev. 11/22