



REFRIGERATION

SERVING THE FOOD INDUSTRY SINCE 1951

SOLID DOOR BOTTLE COOLERS

Item: 50057
Model: BB-CN-0012-SH

Item: 50059
Model: BB-CN-0016-SH

Item: 50061
Model: BB-CN-0020-SH



- These refrigerated back bar coolers are designed with enduring quality and value
- Durable stainless steel top, interior walls, floor and ceiling
- Exterior construction is attractive corrosion resistant vinyl on steel in black finish
- Electronic control system makes it easy to adjust temperature set point and defrost frequency.
- Refrigerant: Hydro-Carbon R290



Authorized Dealer



WARRANTY

2 YEARS PARTS & LABOR
5 YEARS ONLY ON COMPRESSOR



REFRIGERATION

SOLID DOOR BOTTLE COOLERS



50057



50059



50061

49-inch 2 doors bottle cooler

ITEM NUMBER	50057	NUMBER OF SHELVES	4
MODEL	BB-CN-0012-SH	DOOR DIMENSIONS	18.6" x 31.3" / 472 x 795 mm
CAPACITY	11.8 cu. ft. / 335 L	DIMENSIONS (DWH)	48.8" x 24.4" x 37.2" 1240 x 620 x 945 mm
POWER	150 kW	INTERIOR DIMENSIONS (DWH)	36 1/4" x 18 1/2" x 30 1/2" 920 x 470 x 775 mm
COMPRESSOR HP	1/5 HP	PACKAGING DIMENSIONS	51 1/8" x 27 4/8" x 42 3/8" 1300 x 700 x 1075 mm
TEMPERATURE RANGE	33°F - 41°F / 0.5°C - 5°C	WEIGHT	98 kg. / 216 lbs.
AMPS	2.88	PACKAGING WEIGHT	118 kg. / 260 lbs.
ELECTRICAL	115V / 60Hz / 1Ph		
NUMBER OF DOORS	2		

61-inch 2 doors bottle cooler

ITEM NUMBER	50059	NUMBER OF SHELVES	4
MODEL	BB-CN-0016-SH	DOOR DIMENSIONS	24.6" x 31.3" / 624 x 795 mm
CAPACITY	15.8 cu. ft. / 446 L	DIMENSIONS (DWH)	60.8" x 24.4" x 37.2" 1544 x 620 x 945 mm
POWER	150 kW	INTERIOR DIMENSIONS (DWH)	48 1/4" x 18 1/2" x 30 1/2" 1224 x 470 x 775 mm
COMPRESSOR HP	1/5 HP	PACKAGING DIMENSIONS	63 3/8" x 27 4/8" x 42 3/8" 1610 x 700 x 1075 mm
TEMPERATURE RANGE	33°F - 41°F / 0.5°C - 5°C	WEIGHT	116 kg. / 255 lbs.
AMPS	2.88	PACKAGING WEIGHT	145 kg. / 319 lbs.
ELECTRICAL	115V / 60Hz / 1Ph		
NUMBER OF DOORS	2		

73-inch 3 doors bottle cooler

ITEM NUMBER	50061	NUMBER OF SHELVES	6
MODEL	BB-CN-0020-SH	DOOR DIMENSIONS	20" x 31.3" / 510 x 795 mm
CAPACITY	19.6 cu. ft. / 556 L	DIMENSIONS (DWH)	72.8" x 24.4" x 37.2" 1848 x 620 x 945 mm
POWER	196 kW	INTERIOR DIMENSIONS (DWH)	60 1/8" x 18 1/2" x 30 1/2" 1528 x 470 x 775 mm
COMPRESSOR HP	1/4+ HP	PACKAGING DIMENSIONS	75 2/8" x 27 4/8" x 42 3/8" 1910 x 700 x 1075 mm
TEMPERATURE RANGE	33°F - 41°F / 0.5°C - 5°C	WEIGHT	141 kg. / 310 lbs.
AMPS	3.96	PACKAGING WEIGHT	175 kg. / 385 lbs.
ELECTRICAL	115V / 60Hz / 1Ph		
NUMBER OF DOORS	3		

OMCAN INC.

Telephone: 1-800-465-0234

Fax: (905) 607-0234

Email: sales@omcan.com

Website: www.omcan.com



Follow us to keep up to date with the latest news and offers



2017.E.O.E

REFRIGERATION

SOLID DOOR BOTTLE COOLERS



TECHNICAL DRAWINGS AND DIMENSIONS

Item 50057 - BB-CN-0012-SH

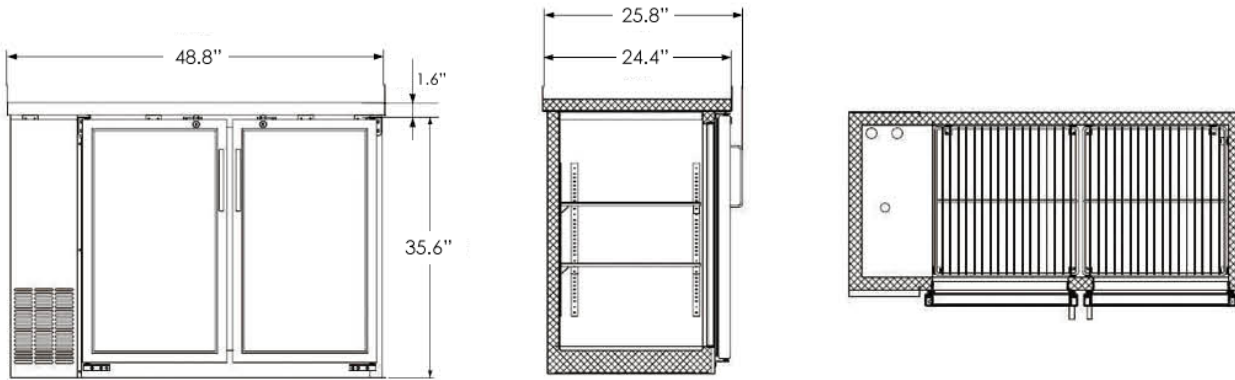

Item 50059 - BB-CN-0016-SH

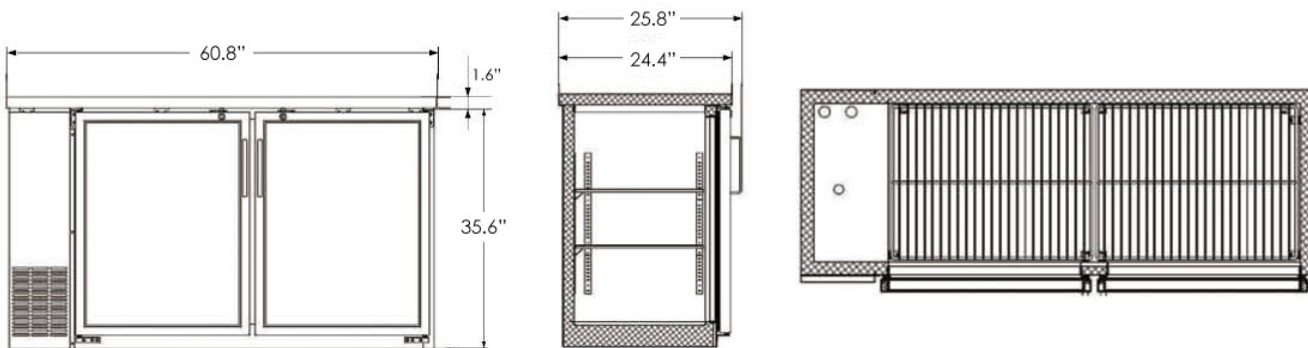

Item 50061 - BB-CN-0020-SH

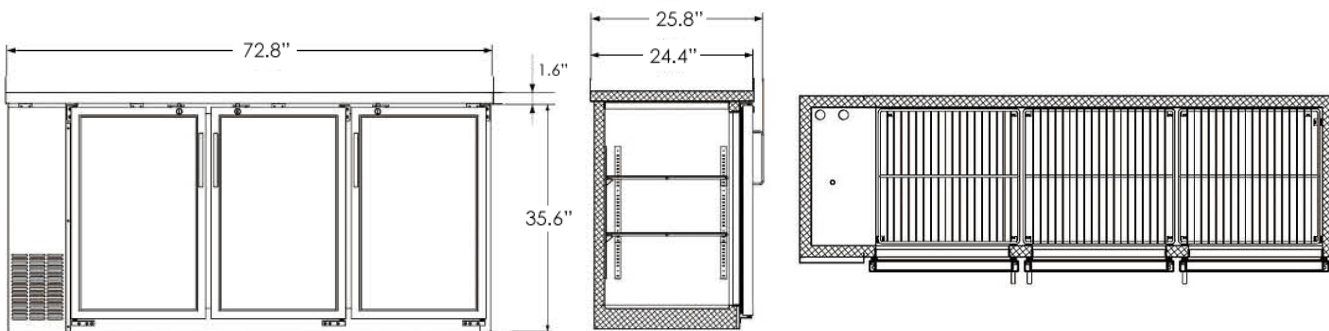

OMCAN INC.

Telephone: 1-800-465-0234
Fax: (905) 607-0234
Email: sales@omcan.com
Website: www.omcan.com



Follow us to keep up to date with the latest news and offers



2017.E.O.E