

Owner's Manual

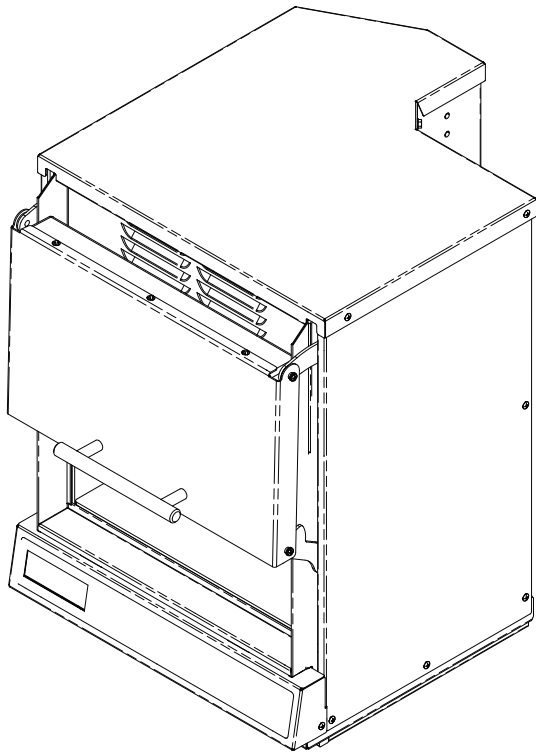

OnCue™ Commercial Microwave Oven

Keep these instructions for future reference.
If the oven changes ownership, this manual must accompany oven.

Contents	
Model Identification	2
PRECAUTIONS TO AVOID POSSIBLE EXPOSURE TO EXCESSIVE MICROWAVE ENERGY	
IMPORTANT SAFETY INSTRUCTIONS...	3
Grounding / Earthing Instructions.....	5
Installation	5
Display and Features	6
Using the Oven Control	8
Programming the Oven Control	9
User Options	10
Care and Cleaning	11
Before Calling for Service	12

Model Identification

When contacting ACP, provide product information.
Product information is located on oven serial plate.
Record the following information:

Model Number: _____

Manufacturing Number: _____

Serial or S/N Number: _____

Date of purchase: _____

Dealer's name and address: _____

Any questions or to locate an authorized servicer, call
1-800-426-2621 inside U.S.A.

1-319-368-8195 outside U.S.A.

If an automated telephone system is reached, select
Commercial Microwave Ovens category.

Warranty service must be performed by an authorized
servicer. ACP also recommends contacting an
authorized servicer if service is required after warranty
expires.

IMPORTANT SAFETY INSTRUCTIONS



Recognize this symbol as a **SAFETY** message



WARNING

When using electrical equipment, basic safety precautions should be followed to reduce the risk of burns, electrical shock, fire, or injury to persons including the following.

1. READ all instructions before using equipment.
2. READ AND FOLLOW the specific "PRECAUTIONS TO AVOID POSSIBLE EXPOSURE TO EXCESSIVE MICROWAVE ENERGY" on this page.
3. This equipment **MUST BE GROUNDED**. Connect only to properly GROUNDED outlet. See "GROUNDING / EARTHING INSTRUCTIONS" on page 5.
4. Install or locate this equipment **ONLY** in accordance with the installation instructions in this manual.
5. Some products such as whole eggs and sealed containers—for example, closed glass jars—are able to explode and **SHOULD NOT** be HEATED in this oven.
6. Use this equipment **ONLY** for its intended use as described in this manual. Do not use corrosive chemicals or vapors in this equipment. This type of oven is specifically designed to heat, cook, or dry food. It is not designed for industrial or laboratory use.
7. This appliance is **NOT** intended for use by persons (including children) with reduced physical, sensory or mental capabilities, or lack of experience and knowledge, unless they have been given supervision or instruction concerning use of the appliance by a person responsible for their safety
8. **CHILDREN SHOULD BE SUPERVISED** to ensure that they **DO NOT** play with the appliance.
9. Failure to maintain the oven in a clean condition could lead to deterioration of the surface that could adversely affect the life of the appliance and possibly result in a hazardous situation;
10. See door cleaning instructions on page 11 of this product safety manual.
11. **DO NOT** heat baby bottles in oven.
12. Baby food jars shall be open when heated and contents stirred or shaken before consumption, in order to avoid burns.
13. **DO NOT** operate this equipment if it has a damaged cord or plug, if it is not working properly, or if it has been damaged or dropped.
14. This equipment, including power cord, must be serviced **ONLY** by qualified service personnel. Special tools are required to service equipment. Contact nearest authorized service facility for examination, repair, or adjustment.
15. **DO NOT** cover or block louvers or other openings on equipment.
16. **DO NOT** store this equipment outdoors. **DO NOT** use this product near water – for example, near a kitchen sink, in a wet basement, a swimming pool, or a similar location.
17. **DO NOT** immerse cord or plug in water.
18. Keep cord **AWAY** from HEATED surfaces.
19. **DO NOT** let cord hang over edge of table or counter.
20. For commercial use only.

PRECAUTIONS TO AVOID POSSIBLE EXPOSURE TO EXCESSIVE MICROWAVE ENERGY

- A. **DO NOT** attempt to operate this oven with the door open since open door operation can result in harmful exposure to microwave energy. It is important not to defeat or tamper with the safety interlocks.
- B. **DO NOT** place any object between the oven front face and the door to allow soil or cleaner residue to accumulate on sealing surfaces.
- C. **DO NOT** operate the oven if it is damaged. It is particularly important that the oven door close properly and that there is no damage to the:
 1. door (bent)
 2. hinges and latches (broken or loosened)
 3. door seals and sealing surfaces.
- D. The oven should not be adjusted or repaired by anyone except properly qualified service personnel.

SAVE THESE INSTRUCTIONS

IMPORTANT SAFETY INSTRUCTIONS



WARNING

To avoid risk of fire in the oven cavity:

- a. DO NOT overcook food. Carefully attend oven when paper, plastic, or other combustible materials are placed inside the oven to facilitate cooking.
- b. Remove wire twist-ties from paper or plastic bags before placing bag in oven.
- c. If materials inside the oven ignite, keep oven door CLOSED, turn oven off and disconnect the power cord, or shut off power at the fuse or circuit breaker panel.
- d. DO NOT use the cavity for storage. DO NOT leave paper products, cooking utensils, or food in the cavity when not in use.



WARNING

Liquids such as water, coffee, or tea are able to be overheated beyond the boiling point without appearing to be boiling due to surface tension of the liquid. Visible bubbling or boiling when the container is removed from the microwave oven is not always present. THIS COULD RESULT IN VERY HOT LIQUIDS SUDDENLY BOILING OVER WHEN A SPOON OR OTHER UTENSIL IS INSERTED INTO THE LIQUID. To reduce the risk of injury to persons:

- i) Do not overheat the liquid.
- ii) Stir the liquid both before and halfway through heating it.
- iii) Do not use straight-sided containers with narrow necks.
- iv) After heating, allow the container to stand in the microwave oven for a short time before removing the container.
- v) Use extreme care when inserting a spoon or other utensil into the container.



CAUTION

To avoid personal injury or property damage, observe the following:

1. Do not deep fat fry in oven. Fat could overheat and be hazardous to handle.
2. Do not cook or reheat eggs in shell or with an unbroken yolk using microwave energy. Pressure may build up and erupt. Pierce yolk with fork or knife before cooking.
3. Pierce skin of potatoes, tomatoes, and similar foods before cooking with microwave energy. When skin is pierced, steam escapes evenly.
4. Do not operate equipment without load or food in oven cavity.
5. Microwave popcorn should not be popped in oven.
6. Do not use regular cooking thermometers in oven. Most cooking thermometers contain mercury and may cause an electrical arc, malfunction, or damage to oven.
7. Do not use metal utensils in oven.
8. Do not use aluminum foil in oven
9. Never use paper, plastic, or other combustible materials that are not intended for cooking.
10. When cooking with paper, plastic, or other combustible materials, follow manufacturer's recommendations on product use.
11. Do not use paper towels which contain nylon or other synthetic fibers. Heated synthetics could melt and cause paper to ignite.
12. Do not heat sealed containers or plastic bags in oven. Food or liquid could expand quickly and cause container or bag to break. Pierce or open container or bag before heating.
13. To avoid pacemaker malfunction, consult physician or pacemaker manufacturer about effects of microwave energy on pacemaker.
14. An authorized servicer MUST inspect equipment annually. Record all inspections and repairs for future use.

SAVE THESE INSTRUCTIONS

Unpacking Oven

- Inspect oven for damage such as dents in door or inside oven cavity.
- Report any dents or breakage to source of purchase immediately.
Do not attempt to use oven if damaged.
- Remove all materials from oven interior.
- If oven has been stored in extremely cold area, wait a few hours before connecting power.

Radio Interference

Microwave operation may cause interference to radio, television, or a similar oven. Reduce or eliminate interference by doing the following:

- Clean door and sealing surfaces of oven according to instructions in *Care and Cleaning* section.
- Place radio, television, etc. as far as possible from oven.
- Use a properly installed antenna on radio, television, etc. to obtain stronger signal reception.

Oven Placement

- Do not install oven next to or above source of heat, such as pizza oven or deep fat fryer. This could cause microwave oven to operate improperly and could shorten life of electrical parts.
- Do not block or obstruct oven louvers.
- Oven may be stacked.
- Install oven on level countertop surface or overshef.
- If provided, place warning label in a conspicuous place close to microwave oven.
- Outlet should be located so that plug is accessible when oven is in place.

For Enclosed Installation

A—Allow at least 2" (5.1 cm) of clearance around top of oven. Proper air flow around oven cools electrical components. With restricted air flow, oven may not operate properly and life of electrical parts is reduced.

B—Allow at least 1 1/4" (3.18 cm) of clearance around air discharge vents on back of oven*

C—Allow at least 1" (2.54 cm) of clearance around sides of oven.

D—Install combination oven so oven bottom is at least 3 feet (91.5 cm) above floor.

Note: Back to back installation allows correct clearance.

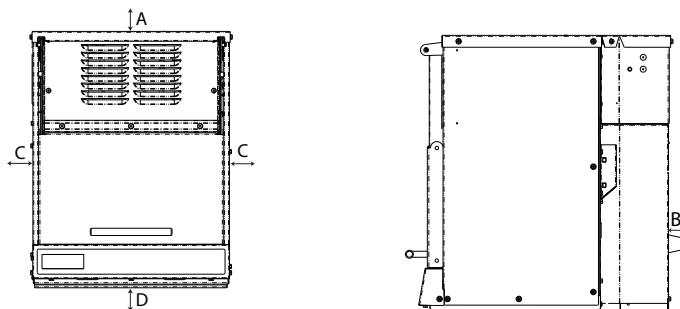

The switching operation of this microwave oven can cause voltage fluctuations on the supply line. The operation of this oven under unfavorable voltage supply conditions can have adverse effects. This device is intended for the connection to a power supply system with a maximum permissible system impedance Z_{max} of **0.31 Ohm** at the interface point of the user's supply. The user has to ensure that this device is connected only to a power supply system which fulfills the requirement above. If necessary, the user can ask the public power supply company for the system impedance at the interface point.

Grounding Instructions

⚠ WARNING

To avoid risk of electrical shock or death, this oven must be grounded.

⚠ WARNING

To avoid risk of electrical shock or death, do not alter the plug.

Oven **MUST** be grounded.

Grounding reduces risk of electric shock by providing an escape wire for the electric current, if an electrical short occurs. This oven is equipped with a cord having a ground wire with a grounding plug. The plug must be plugged into an outlet that is properly installed and grounded.

⚠ WARNING

Improper use of the grounding can result in a risk of electric shock.

Consult a qualified electrician or servicer if grounding instructions are not completely understood, or if doubt exists as to whether the oven is properly grounded.

Do not use an extension cord.

If the product power cord is too short, have a qualified electrician install a three-slot receptacle. This oven should be plugged into a separate circuit with the electrical rating as provided in product specifications (available on acpsolutions.com). When a microwave oven is on a circuit with other equipment, an increase in cooking times may be required and fuses can be blown.

External Equipotential

Earthing Terminal *(export only)*

Equipment has secondary earthing terminal. Terminal provides external earthing connection used in addition to earthing prong on plug. Located on outside of oven back, terminal is marked with symbol shown below.



Display and Features

Start Pad

The start pad is used to begin a manual time entry cooking cycle. It is also used to save any changes to programming sequences or user options.

STOP Pad

The STOP pad stops a cooking sequence in progress, and also ends a programming or user option cycle. When the STOP pad is used to end a programming or option change, the changes are discarded. The STOP pad can also be used to open the door after it has been closed.

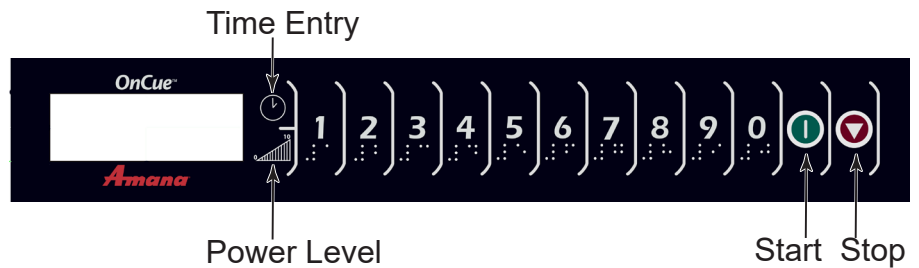

Single Pad Programming

This feature enables each numbered pad to be programmed for a specific use, such as cooking a certain number of potatoes or defrosting and then cooking vegetables or other frozen foods. To use this feature, simply program the pad to the desired length of time and power level. To use this feature, press the pad once and the microwave will begin cooking.

Double Pad Programming

This feature enables 100 programmed entries to be made. Each entry will be assigned a double digit number, for example 01, 05, or 20. When using the double pad programming, two pads must be pressed to start the cooking cycle.

Manual Time Entry

In addition to programmable pads, this microwave also accepts specific time entry by using the TIME ENTRY  pad. Using manual time entry does not affect the programmed buttons.

Stage Cooking

Stage cooking is a cooking sequence with specific power stage changes. The user can program up to four different power level changes and the specific amount of cooking time at each power level. Each power level/cooking time combination is known as a stage. Up to four stages can be programmed.

User Options

This microwave can be set for specific user preferences. Options such as beep volume, maximum cooking time, and the number of programmable pads can be changed. To change different options, see *User Options* in this manual.

Display and Features



Appears after closing the door. Oven is ready to accept entries



Example of display when cooking at variable power.

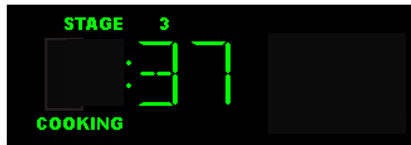

Example of display when cooking at full power.

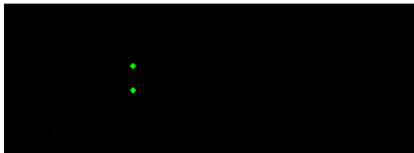

Display when oven sitting idle.

Cooking Display



DISPLAYS	DESCRIPTION
00:00	Displays cooking time. If stage cooking is programmed, total cooking time displays.
50 % MW POWER	50% MW POWER displays the current microwave power level. 100% is the highest setting, and 0% is the lowest. (example of 50 microwave power shown)
STAGE 1, 2, 3, or 4	STAGE 1 displays to show the stage number (1 through 4) the oven is at in the cooking cycle.

Using the Oven Control

Interrupting Operation

Press STOP  pad to interrupt or stop operation.

Canceling Mistakes



- If oven is not cooking, press STOP  pad to clear display.
- If oven is cooking, press STOP  pad once to stop oven.

Open Door

- Press STOP  pad to open door.

Manual Operation

To cook food using a specific entered time and power level.

1. Place food in oven. Close door.
2. Press TIME ENTRY  pad and enter cooking time.
3. Press POWER LEVEL  pad to program level of microwave power if less than 100% is desired.
 - For a lower microwave power, press pads 1 (for 10%), through 9 (for 90%), or 0 for no microwave energy.
4. Press START  pad.
5. At end of cooking cycle oven door opens.
6. Remove food from oven. Door remains open and ready for next item to cook.

Preprogrammed Pads

To cook food using preprogrammed cooking sequences.

1. Place food in oven. Close door.
2. Press desired pad.
3. Oven begins to cook.
4. At end of cooking cycle oven door opens

Factory Settings

Pad	Time	Pad	Time
1	5 sec.	6	30 sec.
2	10 sec.	7	35 sec.
3	15 sec.	8	40 sec.
4	20 sec.	9	45 sec.
5	25 sec.	0	60 sec.



“Factory program times may vary on certain models”

Programming the Oven Control

Programming Items

1. Press and hold pad 1 for approximately 5 seconds.
2. Press pad to be reprogrammed.
3. Enter cooking time by using the number pads.
4. Press POWER LEVEL  pad to program level of microwave power if desired.
 - For a lower microwave power, press pads 1 (for 10%), through 9 (for 90%), or 0 for no microwave energy.

NOTE: Press POWER LEVEL  pad twice to return to 100% microwave power.

5. Press TIME ENTRY  pad to add up to four additional cooking stages.
 - Maximum cooking time cannot exceed 10 minutes per user options.
 - Total cooking time factory setting is 5 minutes.
 - Enter cook time and power level as in steps 4 and 5.
6. Press START  pad to set new programming changes to the pad.

NOTE: To discard changes, press STOP  pad or close oven door.

7. Press STOP  to exit programming mode.

User Options

Changing user options



Didn't like an option?

Factory settings are marked in bold. To change the oven back to the factory setting, simply select the option that is marked in bold.

Changing user options

Options such as single or double pad programming and beep volume can be changed to suit individual preferences.

To change options:

1. Press and hold pad 2 for approximately 5 seconds.
2. Option appears in display.
 - Oven is now in options mode.
3. Press number pad that controls option to be changed.
 - See table below for options.
 - Current option will display.
4. Press number pad again to change the option.
 - Each time pad is pressed, option will change.
 - Match code displayed with code for desired option, then press the START  pad.
 - Changes take effect after the start pad is pressed.
 - To change additional options, repeat steps 3 and 4.
5. Press START  pad to return to Options.
6. Press STOP  to exit.

Numbered Pads	Display	Options (Factory Settings in Bold)
1 End of Cycle Beep	OP:10 OP:11 OP:12 OP:13 OP:14 OP:15 OP:16	3 second continuous beep 5 second beeps once Continuous beep until done disappears Repeating 5 beeps bursts until door is opened Continuous beep until stop pad is pressed or door is cycled Repeating 5 beeps burst until stop pad is pressed or door is cycled No beep
2 Speaker Volume	OP:20 OP:21 OP:22 OP:23	Eliminates beep Sets volume to low Sets volume to medium Sets volume to high
3 Key Beep	OP:30 OP:31	Prevents beep when pad is pressed Allows beep when pad is pressed
4 Keyboard Enable Window	OP:40 OP:41 OP:42 OP:43	15 seconds after oven door is closed, keyboard disabled 30 seconds after oven door is closed, keyboard disabled 1 minute after oven door is closed, keyboard disabled 2 minutes after oven door is closed, keyboard disabled
5 End of Cycle Message Time	OP:50 OP:51 OP:52 OP:53 OP:55 OP:56 OP:57 OP:58 OP:59	10 seconds 20 seconds 30 seconds 40 seconds 60 seconds 1 minute 10 seconds 1 minute 20 seconds 1 minute 30 seconds 1 minute 40 seconds
6 Stop During Cooking Cycle	OP:60 OP:61 OP:62	Pressing stop clears information, opens door Pressing stop pauses oven with door closed Pressing stop pauses oven with door open
7 Maximum Cook Time Entry	OP:70 OP:71	Allows 5 minutes of heating time Allows 10 minutes of heating time
8 Time Entry	OP:80 OP:81	Allows use of preprogrammed pads only Allows use of manual time entry and preprogrammed pads
9 Double Digit Operation	OP:90 OP:91	Allows 10 (0-9) preprogrammed pads Allows 100 (00-99) preprogrammed pads
0 ON-THE-FLY Cooking	OP:00 OP:01	Disables ON-THE-FLY cooking Allows ON-THE-FLY cooking

Care and Cleaning

Microwave energy is attracted to any food source in the oven. Food splatters or spills can affect heating performance, and can also cause oven damage. To prevent damage to oven, keep the microwave oven clean and remove any food debris. Follow the recommendations below for proper maintenance of OnCue™ ovens.

WARNING: NOT FOLLOWING APPROVED OVEN CLEANING INSTRUCTIONS MAY VOID YOUR OVEN WARRANTY

⚠ Do NOT use abrasive cleaners or cleaners containing ammonia, citrus, phosphates, chlorine, sodium or potassium hydroxide (lye). The use of caustic cleaning products or those containing ammonia, citrus, phosphates, chlorine, sodium or potassium hydroxide (lye) can damage critical oven parts.

Use of unapproved cleaning agents will void the terms of the warranty.

⚠ Never pour water into microwave oven bottom.

⚠ Do NOT use water pressure type cleaning systems.

⚠ Do NOT operate oven without the splatter shield in place.

⚠ Never turn on or operate oven during cleaning procedure. Always unplug oven before cleaning.

⚠ WARNING



To avoid electrical shock which can cause severe personal injury or death, unplug power cord or open circuit breaker to oven before cleaning.

Wear protective gloves and protective glasses when cleaning the oven.

Failure to maintain the oven in a clean condition could lead to deterioration of the surface that could adversely affect the life of the appliance and possibly result in a hazardous situation.

Daily Care and Cleaning

INTERIOR OVEN CAVITY

1. Unplug Oven 
2. Remove any food debris 
3. Clean interior of microwave oven with mild detergent and damp soft sponge or cloth. Wring cloth or sponge to remove excess water before wiping equipment.

ANTENNA/SPLATTER SHIELD

The antenna shield (or splatter/grease shield) is a vital part of the oven's design. Clean the shield in place to prevent food splatter/debris from building up on the oven ceiling.

4. Unplug Oven 
5. Spray approved cleaner on clean cloth. 
6. Wipe debris off Antenna/Splatter Shield – Repeat As Needed 

INTERIOR DOOR





7. Unplug Oven 
8. To clean interior door, gently pull out on door until door opens at a 90-degree angle. 
9. Wipe the underside of door and inside door arms with a damp cloth. Wipe dry. 

EXTERIOR OVEN

10. Clean exterior of microwave oven with mild detergent and damp soft sponge or cloth. Wring cloth or sponge to remove excess water before wiping equipment. 

Monthly Care and Cleaning

GLIDE STRIPS

1. Unplug Oven. 
2. Gently pull out on door until door opens at a 90-degree angle. 
3. Clean in between door arms and side of cavity with a cloth (**Do NOT** use paper towels) on the end of a non metallic spatula with mild detergent or degreaser, cleaning the glide strips on both sides of the cavity. 
4. Place door back in ready position by gently pushing downward. 

Before Calling for Service



WARNING

To avoid electrical shock which can cause severe personal injury or death, do not remove outer case at any time. Only an authorized servicer should remove outer case.

Symptom	Possible Cause
Oven does not operate	Confirm oven is plugged into dedicated circuit. Confirm oven is on grounded and polarized circuit (Contact electrician to confirm) Check fuse or circuit breaker.
Oven operates intermittently	Check air louvers and discharge areas for obstructions
If oven does not accept entries when pad is pressed	Make sure oven is on Open and close oven door. Press pad again.
Oven operates but does not heat food	Place one cup of water in oven. Run for 30 seconds at full power (100%) If temperature does not rise, oven is not operating correctly. Contact authorized ACP servicer.
Call Service in display	Unplug oven, wait for 1 minute, and plug in oven. Disconnecting electrical supply may eliminate Call Service. If failure continues, contact an authorized ACP servicer.
If oven door opens slowly	Clean glide strips (see care and cleaning section)

Troubleshooting Tips

If the door does not open after a cooking cycle. Press the stop button. If door still does not open, press stop again. If door still remains closed, gently pull door forward to open manually. If this continues to be an issue, please contact service.

If door does not latch, call service.

International Only
An authorized servicer MUST inspect equipment annually.
Record all inspections and repair for future reference.