



Discover the Art of Display...

Project Name: _____

Item #: _____ Quantity: _____

PROVINO I DELI PASTRY

MODELS: PROVINO I DP700, DP1400, DP1400-2T, DP2100, DP2800

STANDARD FEATURES

- Solid Side
- Dual Medium Temperature Version with intermediate double glass divider
- Triple pane glass premium door
- Steel load bearing structure
- 3000°K LED lighting with dimmer switch
- Touch Control
- Ventilated cooling
- interior vertical shelf support in stainless steel
- adjustable feet
- standard steel 304A
- stainless steel interior and exterior
- Stainless steel shelves adjustable in height on racks
- programmed automatic electric defrost
- Approvals: cETLus, ETL sanitation, certified CE
- Self-contained
- Condensate evaporator pan

OPTIONS

- RAL Color Option powder coated door handles exterior and interior over stainless steel
- 6mm thick stone back panel behind shelf
- Front wood laminate door and handles
- interior shelf trim
- 6mm thick stone back panel behind shelf
- Glass Sides
- Sliding Doors
- Front wood laminate storage doors finish on base
- top door and interior shelf trim
- Top door
- door locks
- Remote application
- Top mounted condensing unit
- water cooled
- central refrigeration rack
- 60 Hz components UL
- Narrow depth
- front breathing available for 1400 - 2800 models



Provino I with optional glass side

Visit our website for optional RAL colors and Materials finishes.

[RAL Colors Website](#)

[Materials Brochure PDF](#)

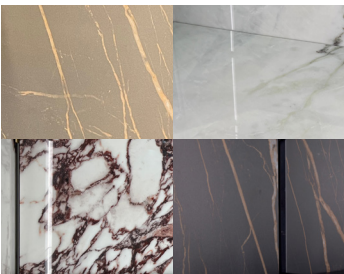

Examples of optional 6mm thick stone back panel behind shelf. For full selection see our Materials Brochure.

*Oscartek® reserves the right to change, modify, discontinue, or change any features, sizes, or capacity on any model without prior notice.



OSCARTEK®
512 South Airport Blvd., South San Francisco, CA 94080
Tel: 855.885.2400 | 650.342.2400 | Fax: 650.342.7400
sales@oscartek.com | www.oscartek.com

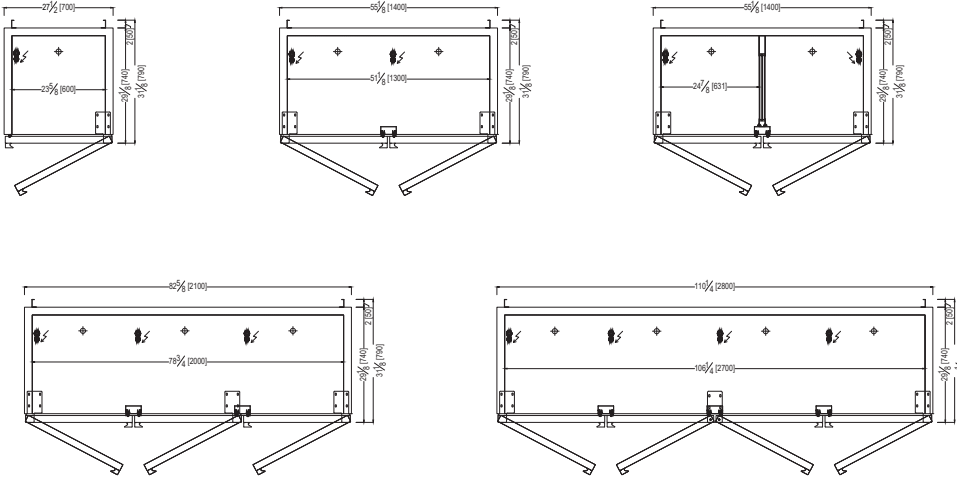

MODELS: PROVINO I DP700, DP1400, DP1400-2T, DP2100, DP2800

**PROVINO I
PLAN VIEWS**



ELECTRICAL LEGEND	
	REFRIGERATION LINES
	DRAIN
	POWER

**PROVINO I
REAR ELEVATIONS (OPERATOR SIDE)**

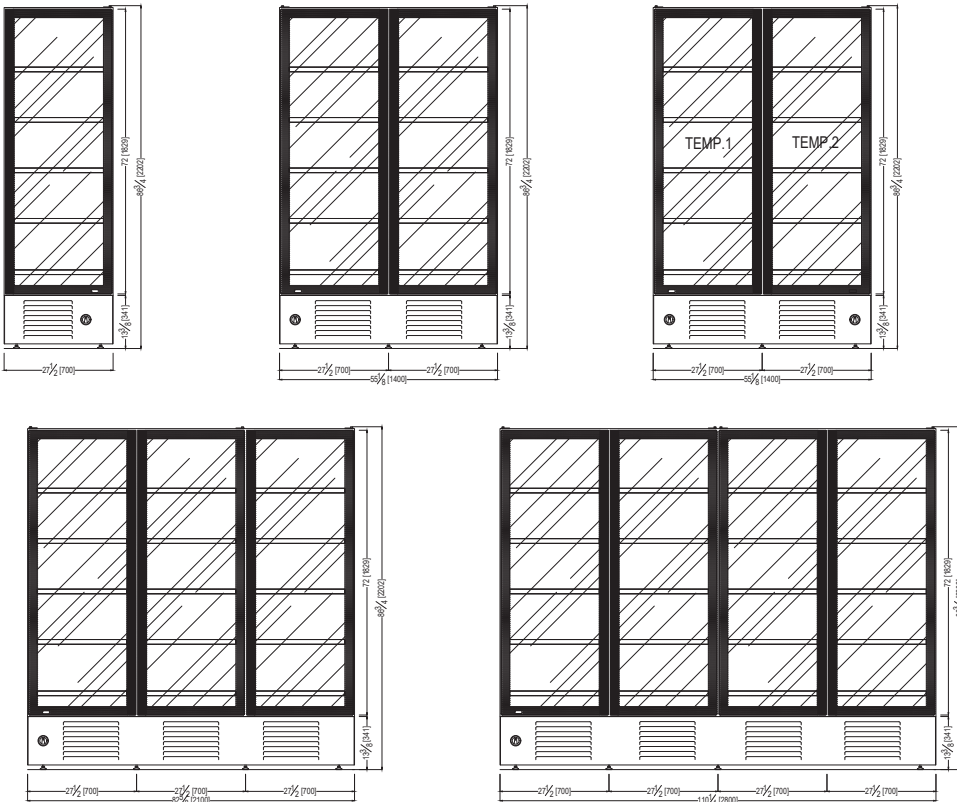

*Oscartek® reserves the right to change, modify, discontinue, or change any features, sizes, or capacity on any model without prior notice.

OSCARTEK®
512 South Airport Blvd., South San Francisco, CA 94080
Tel: 855.885.2400 | 650.342.2400 | Fax: 650.342.7400
sales@oscartek.com | www.oscartek.com



MODELS: PROVINO I DP700, DP1400, DP1400-2T, DP2100, DP2800

PROVINO I - STANDARD DEPTH SECTION VIEWS

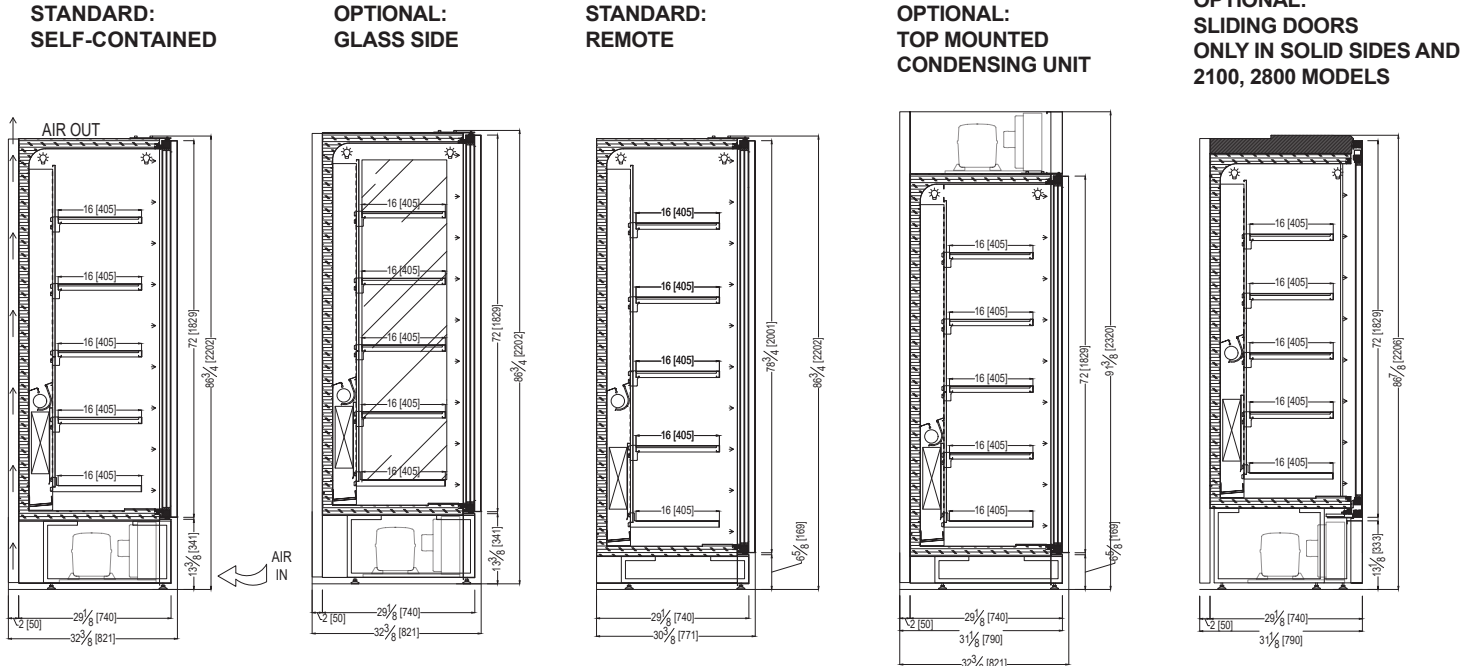

PROVINO I - NARROW DEPTH SECTION VIEWS

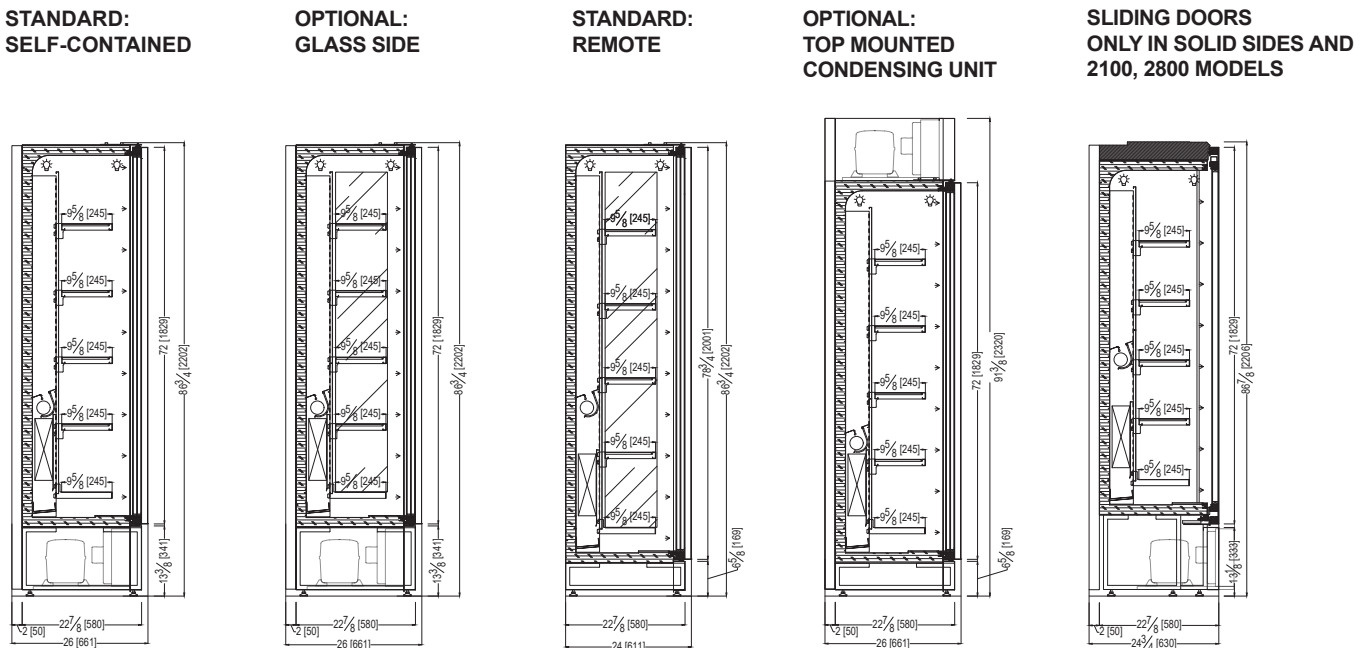

*Oscartek® reserves the right to change, modify, discontinue, or change any features, sizes, or capacity on any model without prior notice.



Discover the Art of Display...

Project Name: _____

Item #: _____ Quantity: _____

MODELS: PROVINO I DP700, DP1400, DP1400-2T, DP2100, DP2800

PROVINO I DELI PASTRY - SELF CONTAINED						
TECHNICAL FEATURES		MODELS				
Model Name (Model ETL Code)		PROVINO I DP700 (MUROGALA1P)	PROVINO I DP1400 (MUROGALA2P)	PROVINO I DP1400-2T (MUROGALA1P)X2	PROVINO I DP2100 (MUROGALA3P)	PROVINO I DP2800 (MUROGALA4P)
External Dimensions (L-D-H) Inches-MM	Inches MM	*27 1/2" - 32 3/8" - 86 3/4" *700 - 821 - 2022	*55 1/8" - 32 3/8" - 86 3/4" *1400 - 821 - 2022	*55 1/8" - 32 3/8" - 86 3/4" *1400 - 821 - 2022	*82 5/8" - 32 3/8" - 86 3/4" *2100 - 821 - 2022	*110 1/4" - 32 3/8" - 86 3/4" *2800 - 821 - 2022
Crated Dimensions (L-D-H) Inches-MM	Inches MM	35" - 39" - 98" 880 - 970 - 2470	63" - 39" - 98" 1580 - 970 - 2470	63" - 39" - 98" 1580 - 970 - 2470	90" - 39" - 98" 2280 - 970 - 2470	118" - 39" - 98" 2980 - 970 - 2470
Refrigeration	Type	Fan - Ventilated	Fan - Ventilated	Fan - Ventilated	Fan - Ventilated	Fan - Ventilated
Refrigeration Display Area	Type	Deck	Deck	Deck	Deck	Deck
Number of Glass Doors	#	1	2	2	3	4
Operating Temperature	°F	32°F to 41°F	32°F to 41°F	32°F to 41°F	32°F to 41°F	32°F to 41°F
Condensing Units	#	1	2	2	3	4
Compressor	Nr./Type	1 / Hermetic	1 / Hermetic	1 / Hermetic	1 / Hermetic	2 / Hermetic
Electric Supply	(V/Ph/Hz)	220/1/60	220/1/60	(2) 220/1/60	220/1/60	220/1/60
Power Consumption	(W/A)	700/3.9	1200/6.9	(2) 650/3.5	1700/9.5	2300/12.9
Defrost	Mode/Type	Automatic	Automatic	Automatic	Automatic	Automatic
Climatic Class	°F/%RH	75°F-55%RH	75°F-55%RH	75°F-55%RH	75°F-55%RH	75°F-55%RH
Refrigerant Gas	Type	R290	R290	R290	R290	R291
Net Weights	Lb	309	573	661	750	904
Crated Weights	Lb	369	633	721	810	964

*DIMENSIONS WITH POLISHED S/S SIDES

PROVINO I DELI PASTRY - REMOTE						
TECHNICAL FEATURES		MODELS				
Model Name (Model Code)		PROVINO I DP700 (MUROGALA1P)	PROVINO I DP1400 (MUROGALA2P)	PROVINO I DP1400-2T (MUROGALA1P)X2	PROVINO I DP2100 (MUROGALA3P)	PROVINO I DP2800 (MUROGALA4P)
External Dimensions (L-D-H) Inches-MM	Inches MM	*27 1/2" - 30 3/8" - 86 3/4" *700 - 771 - 2022	*55 1/8" - 30 3/8" - 86 3/4" *1400 - 771 - 2022	*55 1/8" - 30 3/8" - 86 3/4" *1400 - 771 - 2022	*82 5/8" - 30 3/8" - 86 3/4" *2100 - 771 - 2022	*110 1/4" - 30 3/8" - 86 3/4" *2800 - 771 - 2022
Crated Dimensions (L-D-H) Inches-MM	Inches MM	35" - 39" - 98" 880 - 970 - 2470	63" - 39" - 98" 1580 - 970 - 2470	63" - 39" - 98" 1580 - 970 - 2470	90" - 39" - 98" 2280 - 970 - 2470	118" - 39" - 98" 2980 - 970 - 2470
Refrigeration	Type	Fan - Ventilated	Fan - Ventilated	Fan - Ventilated	Fan - Ventilated	Fan - Ventilated
Refrigeration Display Area	Type	Deck	Deck	Deck	Deck	Deck
Number of Glass Doors	#	1	2	2	3	4
Operating Temperature	°F	32°F to 41°F	32°F to 41°F	32°F to 41°F	32°F to 41°F	32°F to 41°F
Condensing Units	#	1	2	2	3	4
Compressor	Nr./Type	1 / Hermetic	1 / Hermetic	1 / Hermetic	1 / Hermetic	2 / Hermetic
BTU'S @ +14°F Evap Temperature	BTU/H	2730	4980	(2) 2500	6830	7950
Electric Supply	(V/Ph/Hz)	220/1/60	220/1/60	(2) 220/1/60	220/1/60	220/1/60
Power Consumption	(W/A)	700/3.9	1200/6.9	(2) 650/3.5	1700/9.5	2300/12.9
Defrost	Mode/Type	Automatic	Automatic	Automatic	Automatic	Automatic
Climatic Class	°F/%RH	75°F-55%RH	75°F-55%RH	75°F-55%RH	75°F-55%RH	75°F-55%RH
Refrigerant Gas	Type	R452a	R452a	R452a	R452a	R452a
Pipe Size (Suction-Liquid)	(INCHES)	15/32"- 15/64"	35/64" - 5/16"	(2) 15/32"- 15/64"	5/8" - 5/16"	45/64" - 25/64"
Net Weights	Lb	309	573	661	750	904
Crated Weights	Lb	369	633	721	810	964

*DIMENSIONS WITH POLISHED S/S SIDES

*Oscartek® reserves the right to change, modify, discontinue, or change any features, sizes, or capacity on any model without prior notice.

OSCARTEK®
512 South Airport Blvd., South San Francisco, CA 94080
Tel: 855.885.2400 | 650.342.2400 | Fax: 650.342.7400
sales@oscartek.com | www.oscartek.com

