



STANDARD FEATURES

- Molded heat-insulated tank coated by stainless steel
- Static refrigeration with coil into the plane and thermostatic valve
- Stainless steel trays in polished finished
- Digital control panel
- LCD temperature

TAPAS DISPLAY (CURVED GLASS)						
MODELS	LENGTHS	DEPTH	HEIGHT	WEIGHTS (LBS)	VOLTAGES	AMPS
TC900	35 7/16" (900mm)	14 9/16" (370mm)	8 5/16" (211mm)	50lbs	120V	1A
TC900T*	48 5/16" (1228mm)	14 9/16" (370mm)	8 5/16" (211mm)	85lbs	120V	4A
TC1250	49 1/4" (1250mm)	14 9/16" (370mm)	8 5/16" (211mm)	75lbs	120V	1.1A
TC1250T*	62 1/8" (1578mm)	14 9/16" (370mm)	8 5/16" (211mm)	110lbs	120V	5A
TCA90	29 1/2" (750mm)	14 9/16" (370mm)	8 5/16" (211mm)	78lbs	120V	1.1A
TCA90T*	42 7/16" (1078mm)	14 9/16" (370mm)	8 5/16" (211mm)	154lbs	120V	4A

* T = SELF CONTAINED

* Manufacturer reserves the right to change specifications without notice. Not responsible for error and omissions.



361-367 Beach Road, Burlingame, CA 94010
 Tel: 855.885.2400 | 650.342.2400 | Fax: 650.342.7400
 sales@oscartek.com | www.oscartek.com



TC SERIES FRONT COUNTERS

TAPAS DISPLAY CURVED GLASS

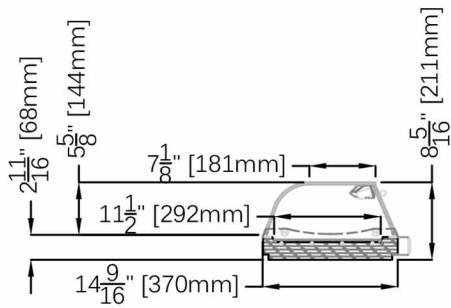

TC900

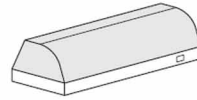

TC900T

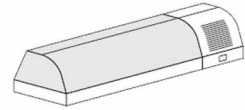

TC1250

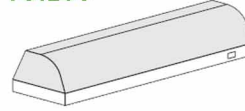

TC1250T

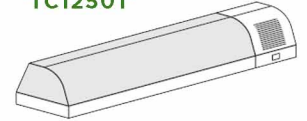

TCA90

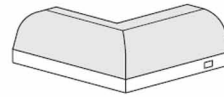

TCA90T

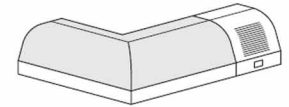

PLAN VIEWS

REMOTE:

TC900

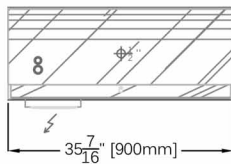

TC1250

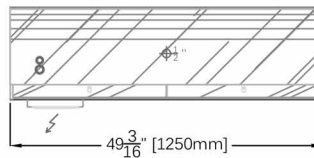

TCA90

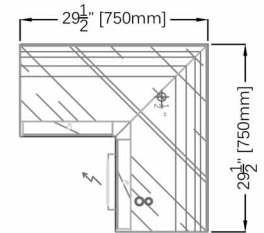

SELF-CONTAINED:

TC900T

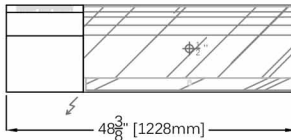

TC1250T

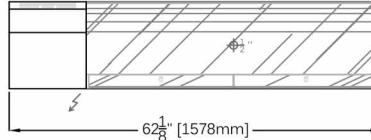

TCA90T

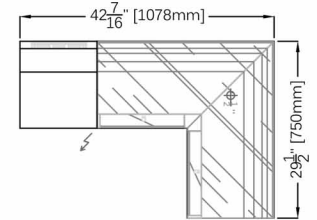

REAR ELEVATIONS (OPERATOR SIDE)

REMOTE:

TC900

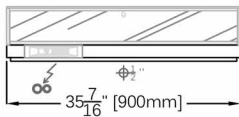

TC1250

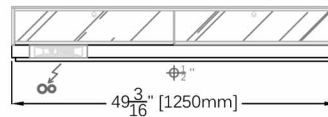

TCA90

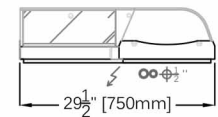

SELF-CONTAINED:

TC900T

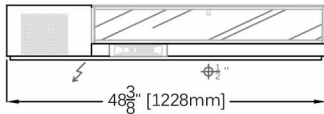

TC1250T



TCA90T

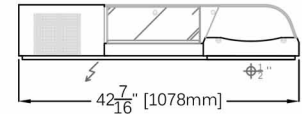

* Manufacturer reserves the right to change specifications without notice. Not responsible for error and omissions.



361-367 Beach Road, Burlingame, CA 94010
Tel: 855.885.2400 | 650.342.2400 | Fax: 650.342.7400
sales@oscartek.com | www.oscartek.com

