



Rosita Bisani

SPECIALTY FOOD SERVICES EQUIPMENT

Synchro 3 3 Group Espresso Machine



STANDARD FEATURES

- Three group automatic espresso machine with 1-6 cup simultaneous delivery capacity
- Volumetric touchpad with programmable dosages
- Automatic back-flush cleaning program per group
- Independent Continuous button for semi-automatic operation
- Two Stainless Steel Swivel Steam jets
- One Stainless Steel hot water jet
- Sleek, modern, and art decorative design
- LCD Display with Variety of Programmable Parameters (Shot Timers, Date, Time, Service Info, etc)
- Classic thermal brewing group with dynamic pre-infusion ensures optimal espresso extraction
- Certified ETL, NSF



Optional

- Available Colors: Black, Red, Chrome, Orange, White
- Deep Drip Tray to Accommodate Large Take Out Cups
- APS Automatic Steam Wand for Cappuccino and Latte

ITEM:

PROJECT:

DATE:

**Synchro 3
3 Group Espresso Machine**

Synchro 3 3 Group Espresso Machine

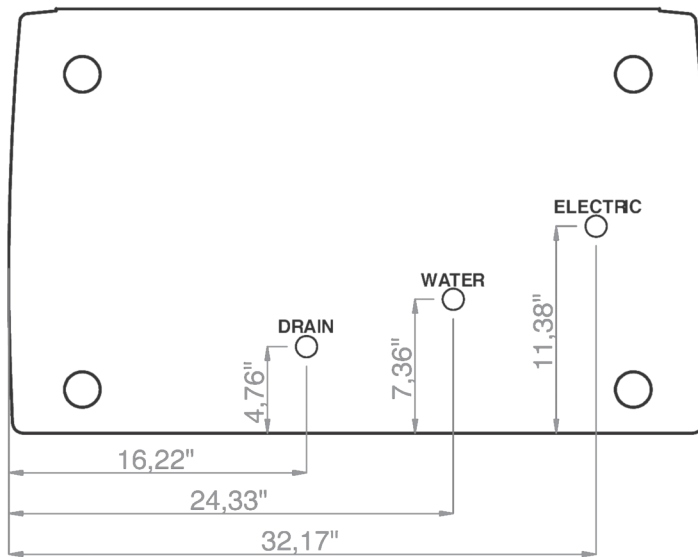
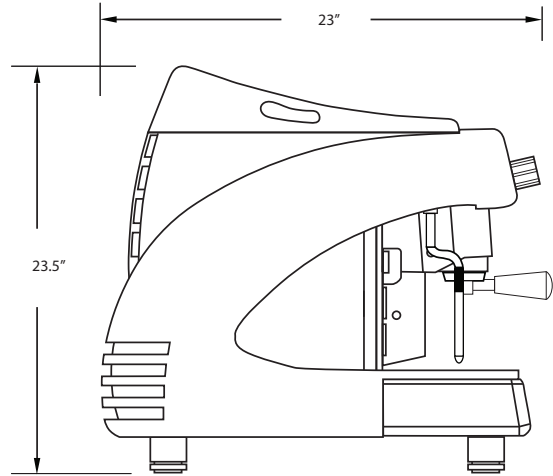
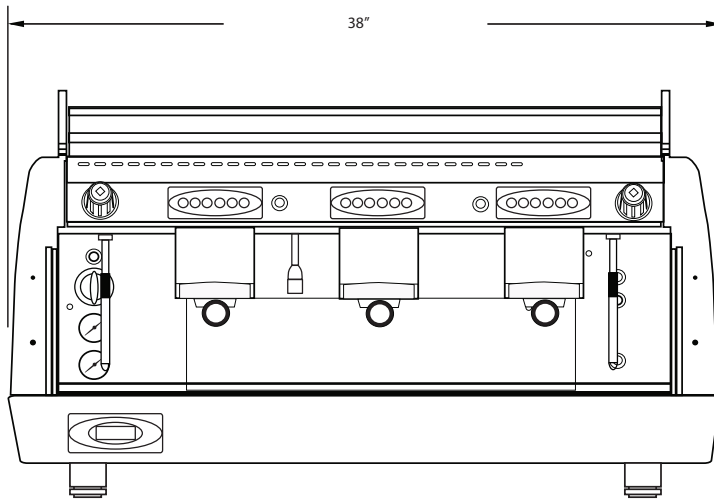

FRONT (BOTTOM VIEW)

BREW DEVICE	CUPS PER GROUP	W x D x H	BOILER CAPACITY (liters)	V.	AMP.	P.H.	Hz	WATTS	WEIGHT (Kg./Lbs.)	SHIPPING WEIGHT (Kg./Lbs.)	INCOMING H ₂ O	DRAIN	MIN/MAX bar
3	6	38 x 23 x 23.5	21	220	21	1	60	4600	85/185	92/203	3/8" MALE	Ø9mm INTERNAL	2 / 5

Rosito Bisani Imports, Inc.
940 South La Brea Avenue, Los Angeles CA, 90036
Tel: 323-937-1888 • Fax: 323-938-0728 • Toll Free: 1-800-848-4444
E-mail: sales@rosito-bisani.com

www.rosito-bisani.com

530 South Henderson Road, Suite F, King of Prussia PA, 19406
Tel: 610-265-5950 • Fax: 888-576-8524
E-mail: rbe@rosito-bisani.com



Intertek