

# PROVINO II DELI PASTRY

**MODELS:** PROVINO II DP700, DP800, DP1390, DP1390-2T, DP2075

## STANDARD FEATURES

- Glass sides and back
- Dual Medium Temperature Version with intermediate double glass divider
- Triple pane glass premium door
- Steel load bearing structure
- 3000°K LED lighting with dimmer switch
- Touch Control
- Ventilated cooling
- interior vertical shelf support in stainless steel
- adjustable feet
- standard steel 304A
- stainless steel interior and exterior
- Glass shelves adjustable in height on racks (7 shelves included per door)
- programmed automatic electric defrost
- Approvals: cETLus, ETL sanitation, certified CE
- Self-contained
- Condensate evaporator pan



Provino II Deli/Pastry

Visit our website for optional RAL colors and Materials finishes.

[RAL Colors Website](#)

[Materials Brochure PDF](#)

## OPTIONS



- RAL Color Option powder coated door handles exterior and interior over stainless
- Front wood laminate door and handles
- interior shelf trim
- Front wood laminate storage doors finish on base
- top door and interior shelf trim
- Top door
- door locks
- Remote application
- Top mounted condensing unit
- water cooled
- central refrigeration rack
- 60 Hz components UL
- 6mm thick stone back panel behind shelf
- Narrow Depth
- front breathing available for 1400 - 2800 models

\*Oscartek® reserves the right to change, modify, discontinue, or change any features, sizes, or capacity on any model without prior notice.

**MODELS:** PROVINO II DP700, DP800, DP1390, DP1390-2T, DP2075

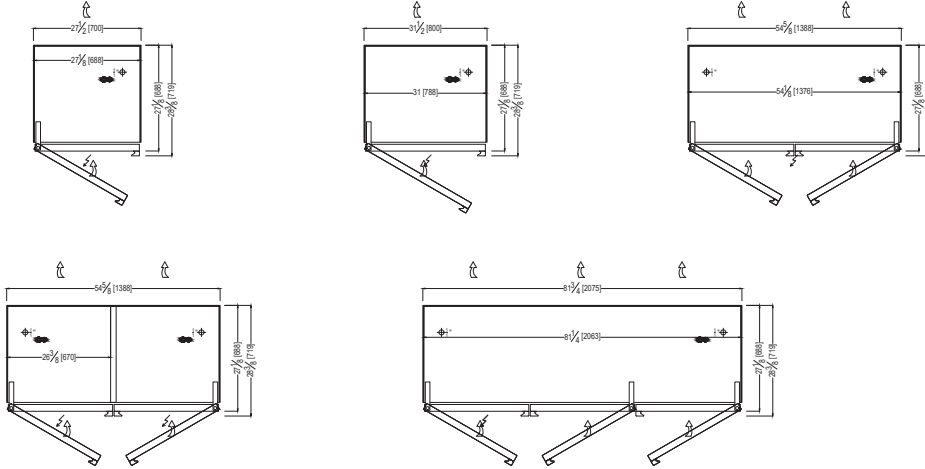
**PROVINO II  
PLAN VIEWS**



ELECTRICAL LEGEND	
	REFRIGERATION LINES
	DRAIN
	POWER

**PROVINO II  
REAR ELEVATIONS (OPERATOR SIDE)**

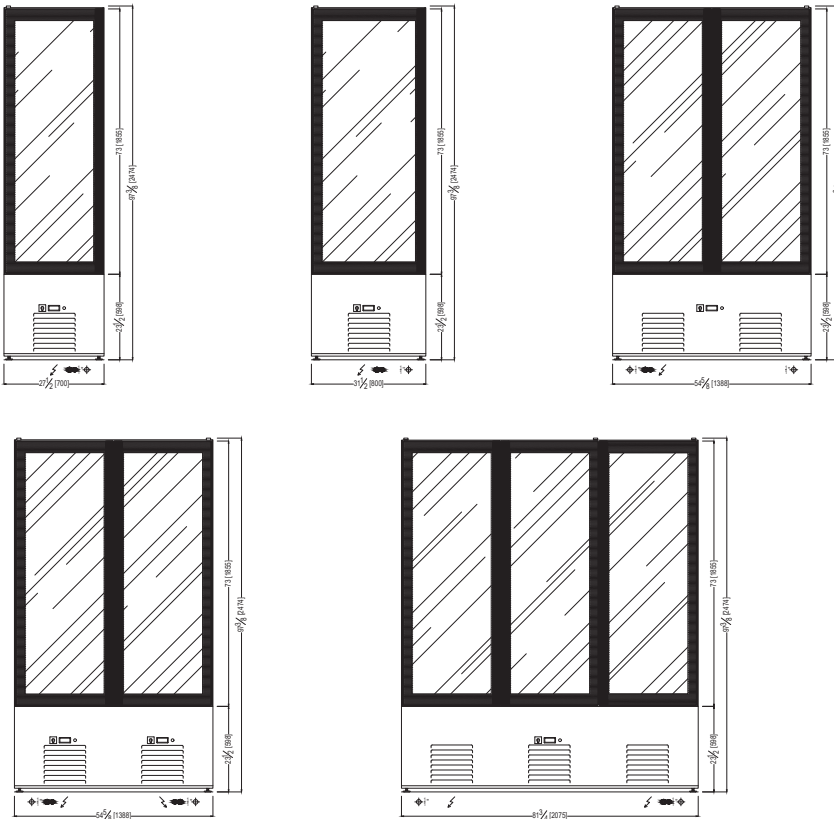

\*Oscartek® reserves the right to change, modify, discontinue, or change any features, sizes, or capacity on any model without prior notice.

OSCARTEK®  
512 South Airport Blvd., South San Francisco, CA 94080  
Tel: 855.885.2400 | 650.342.2400 | Fax: 650.342.7400  
sales@oscartek.com | www.oscartek.com



**MODELS:** PROVINO II DP700, DP800, DP1390, DP1390-2T, DP2075

**PROVINO II  
SECTION VIEWS**

**STANDARD:  
SELF-CONTAINED**

**STANDARD:  
REMOTE WITH  
VERTICAL SHELVES**

**OPTIONAL:  
TOP MOUNTED  
CONDENSING UNIT**

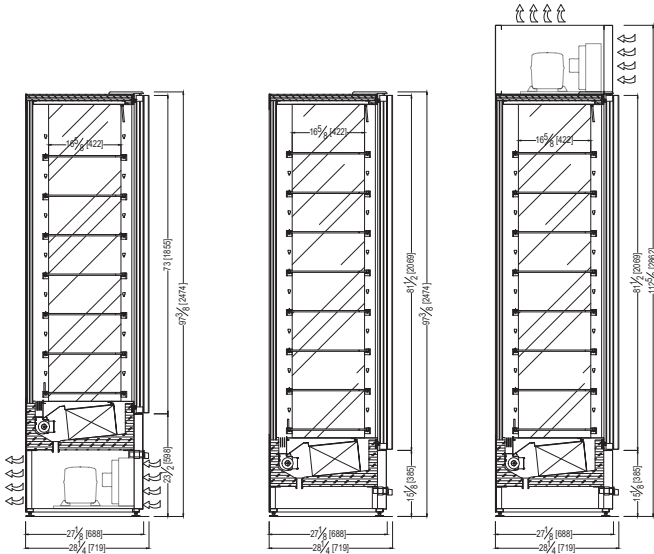

**PROVINO II - WITH FRONT AND REAR DOORS  
SECTION VIEWS**

**OPTIONAL:  
TOP MOUNTED  
CONDENSING UNIT**

**STANDARD:  
REMOTE**

**STANDARD:  
SELF-CONTAINED**

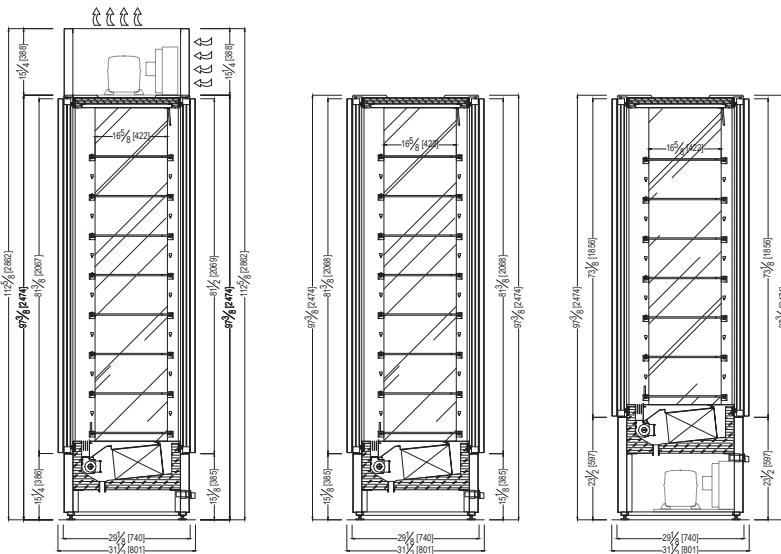

\*Oscartek® reserves the right to change, modify, discontinue, or change any features, sizes, or capacity on any model without prior notice.



Discover the Art of Display...

Project Name: \_\_\_\_\_

Item #: \_\_\_\_\_ Quantity: \_\_\_\_\_

**MODELS: PROVINO II DP700, DP800, DP1390, DP1390-2T, DP2075**

PROVINO II DELI PASTRY - SELF CONTAINED						
TECHNICAL FEATURES		MODELS				
Model Name (Model Code)		PROVINO II DP700 (PROVINO1P)	PROVINO II DP800 (PROVINO1P)	PROVINO II DP1390 (PROVINO2P)	PROVINO II DP1390-2T (PROVINO1P)X2	PROVINO II DP2075 (PROVINO3P)
External Dimensions (L-D-H)	Inches	*27 1/2" - 28 1/4" - 97 3/8"	*31 1/2" - 28 1/4" - 97 3/8"	*54 5/8" - 28 1/4" - 97 3/8"	*82 5/8" - 28 1/4" - 97 3/8"	*81 3/4" - 28 1/4" - 97 3/8"
Inches-MM	MM	*700 - 719 - 2474	*800 - 719 - 2474	*1388 - 719 - 2474	*1388 - 719 - 2474	*2075 - 719 - 2474
Crated Dimensions (L-D-H)	Inches	35" - 35" - 108"	38 3/5" - 35" - 108"	61 4/5" - 35" - 108"	62 4/5" - 35" - 108"	88 4/5" - 35" - 108"
Inches-MM	MM	880 - 870 - 2744	980 - 870 - 2745	1570 - 870 - 2746	1570 - 870 - 2746	2255 - 870 - 2748
Refrigeration	Type	Fan - Ventilated	Fan - Ventilated	Fan - Ventilated	Fan - Ventilated	Fan - Ventilated
Refrigeration Display Area	Type	Deck	Deck	Deck	Deck	Deck
Number of Glass Doors	#	1	2	2	3	4
Operating Temperature	°F	32°F to 41°F	32°F to 41°F	32°F to 41°F	32°F to 41°F	32°F to 41°F
Condensing Units	#	1	2	2	3	4
Compressor	Nr./Type	1 / Hermetic	1 / Hermetic	1 / Hermetic	1 / Hermetic	2 / Hermetic
Electric Supply	(V/Ph/Hz)	220/1/60	220/1/60	220/1/60	(2) 220/1/60	220/1/60
Power Consumption	(W/A)	700/3.8	700/3.8	1360/7.6	(2) 680/3.6	1970/11.1
Defrost	Mode/Type	Automatic	Automatic	Automatic	Automatic	Automatic
Climatic Class	°F/%RH	75°F-55%RH	75°F-55%RH	75°F-55%RH	75°F-55%RH	75°F-55%RH
Refrigerant Gas	Type	R290	R290	R290	R290	R291
Net Weights	Lb	551	617	816	838	1080
Crated Weights	Lb	600	680	880	920	1160

\*DIMENSIONS WITH POLISHED S/S SIDES

PROVINO II DELI PASTRY - REMOTE						
TECHNICAL FEATURES		MODELS				
Model Name (Model Code)		PROVINO II DP700 (PROVINO1P)	PROVINO II DP800 (PROVINO1P)	PROVINO II DP1390 (PROVINO2P)	PROVINO II DP1390-2T (PROVINO1P)X2	PROVINO II DP2075 (PROVINO3P)
External Dimensions (L-D-H)	Inches	*27 1/2" - 28 1/4" - 97 3/8"	*31 1/2" - 28 1/4" - 97 3/8"	*54 5/8" - 28 1/4" - 97 3/8"	*82 5/8" - 28 1/4" - 97 3/8"	*81 3/4" - 28 1/4" - 97 3/8"
Inches-MM	MM	*700 - 719 - 2474	*800 - 719 - 2474	*1388 - 719 - 2474	*1388 - 719 - 2474	*2075 - 719 - 2474
Crated Dimensions (L-D-H)	Inches	35" - 35" - 108"	38 3/5" - 35" - 108"	61 4/5" - 35" - 108"	62 4/5" - 35" - 108"	88 4/5" - 35" - 108"
Inches-MM	MM	880 - 870 - 2744	980 - 870 - 2745	1570 - 870 - 2746	1570 - 870 - 2746	2255 - 870 - 2748
Refrigeration	Type	Fan - Ventilated	Fan - Ventilated	Fan - Ventilated	Fan - Ventilated	Fan - Ventilated
Refrigeration Display Area	Type	Deck	Deck	Deck	Deck	Deck
Number of Glass Doors	#	1	2	2	3	4
Operating Temperature	°F	45°F to 58°F	45°F to 58°F	45°F to 58°F	45°F to 58°F	45°F to 58°F
Condensing Units	#	1	2	2	3	4
Compressor	Nr./Type	1 / Hermetic	1 / Hermetic	1 / Hermetic	1 / Hermetic	2 / Hermetic
BTU'S @ +14°F Evap Temperature		2900	3240	4950	(2) 2400	7200
Electric Supply	(V/Ph/Hz)	220/1/60	220/1/60	220/1/60	(2) 220/1/60	220/1/60
Power Consumption	(W/A)	700/3.8	700/3.8	1360/7.6	(2) 680/3.6	1970/11.1
Defrost	Mode/Type	Automatic	Automatic	Automatic	Automatic	Automatic
Climatic Class	°F/%RH	75°F-55%RH	75°F-55%RH	75°F-55%RH	75°F-55%RH	75°F-55%RH
Refrigerant Gas	Type	R452a	R452a	R452a	R452a	R452a
Pipe Size (Suction-Liquid)	(INCHES)	15/32"- 15/64"	15/32"- 15/64"	35/64"- 5/16"	(2) 15/32"- 15/64"	5/8" - 5/16"
Net Weights	Lb	551	617	816	838	1080
Crated Weights	Lb	600	680	880	920	1160

\*DIMENSIONS WITH POLISHED S/S SIDES

\*Oscartek® reserves the right to change, modify, discontinue, or change any features, sizes, or capacity on any model without prior notice.

OSCARTEK®  
 512 South Airport Blvd., South San Francisco, CA 94080  
 Tel: 855.885.2400 | 650.342.2400 | Fax: 650.342.7400  
 sales@oscartek.com | www.oscartek.com

