

EBC Series

Model: EBC80



Refrigeration System

- Side mounted, self-contained and fully detachable Blizzard R290 condensing unit uses environmentally friendly, EPA-compliant R290 refrigerant with zero (0) Ozone Depletion Potential (ODP) and three (3) Global Warming Potential (GWP). Blizzard R290 is easily replaceable and requires no on-site brazing.
- Electronically commutated (ECM) fan motors achieve rapid cooling with less energy consumption.
- Full-length air duct system ensures optimal circulation of cold air.
- Time-initiated and temperature-terminated auto defrost cycle for seamless operation.
- Large capacity, corrosion-resistant condenser and evaporator coils.
- Self-maintaining, energy-efficient condensate drain pan requires no external drains or electric heaters.
- High performance, auto-reverse condenser fan motor supports compressor ventilation and condenser coil cleaning. Refer to owner's manual for full maintenance instructions.
- Pre-wired and ready to plug, 115V/60Hz/1Ph, NEMA 5-15P.

Cabinet Construction

- Heavy duty stainless steel countertop and rails with textured laminate, black vinyl exterior.
- Open spaced interior with no walls between compartments.
- Galvanized steel interior.
- 1 3/4" thick high density polyurethane insulation.
- Built-in caster thread receptacles for all models.

Lighting

- Shielded LED bar lighting with on/off switch provides bright, high color illumination at lower heat output.

Bottle Cap Opener

- Front mounted bottle cap opener and cap catcher are removable for ease of cleaning.

Lids

- Heavy duty stainless steel exterior and galvanized steel interior.
- 3/4" thick high density polyurethane insulation.
- Removable ratchet locks keep your items safe from theft.

Shelving

- Horizontal epoxy coated, steel wire shelves for bottom air circulation (see table for quantity).
- Vertical epoxy coated, steel wire bin dividers (see table for quantity).

Temperature Control

- Multi-function digital controller with easy to read LED display.
- Factory preset temperature, 35°F.
- Temperature setting range from 33°F to 54°F.
- Audible overheat protection alarm for compressor and condenser coil.

Options

- Additional bin dividers.
- 3" or 5" swivel casters with locks.
- 3.5" – 6" height-adjustable and interchangeable legs.



Please visit our website for updated Energy Efficiency information

Ref/ Frz/Dual	Lids	Capacity			Dividers	Shelves	Refrigerant	HP	Power V-Hz-Ph	Amps	Crated Weight	Exterior Dimensions		
		Cu. Ft.	12 oz. Cans	12 oz. Bottles								L	D	H*
REF	3	26	1008	720	5	3	R-290	1/3	115-60-1	2.5	420 lbs (190kg)	80.5" (2045mm)	26.75" (679mm)	33.75" (857mm)

(†) Based on evaporating temperature of 23°F (-5°C) & condensing temperature of 131°F (55°C). (►) Product capacity is calculated based on standard industry figures. (✳) Reference plan view for clarification on caster/unit height. If dimensions and capacity are critical, please contact Everest Refrigeration. Blizzard R290 replacement is at the sole discretion of Everest Refrigeration. Specifications subject to change without notice.

HORIZONTAL BOTTLE COOLER

EBC Series Model: EBC80

DIMENSIONAL DATA

External Dimensions	L	80.5" (2045mm)
	D	26.75" (679mm)
	H*	33.75" (857mm)
Crated Weight		420 lbs. (190kg)
Doors/Drawers/Lids		3
Max Weight Support (LBS)		-

STORAGE DATA

Net Capacity Cu. Ft. ▶	26
Shelves	3
Barrels	-
20 oz. Bottles	-
12 oz. Bottles	720
12 oz. Cans	1008
8" Mugs	-
# of Pans (Top)	-
# of Pans (Drawer)	-
Dividers	5
Trays	-

ELECTRICAL DATA

Voltage	115-60-1
Full Load Amperage	2.5A
Feed Wires with Ground	3
Cord Length	9ft
NEMA Plug Type	 NEMA 5-15P

REFRIGERATION DATA

Compressor Mounting	Side
Refrigerant	R-290
Compressor HP	1/3
BTU/HR †	2311

KEY

D	Door	R	Refrigerator
L	Lid	REF	Refrigerator
H	Half Door	F	Freezer
FD	Full Door	FRZ	Freezer
SD	Solid Door	DUAL	REF/FRZ Combo
GD	Glass Door	DR	Drawer

	Elevation	Right	Plan	3D	Back

PLAN VIEW

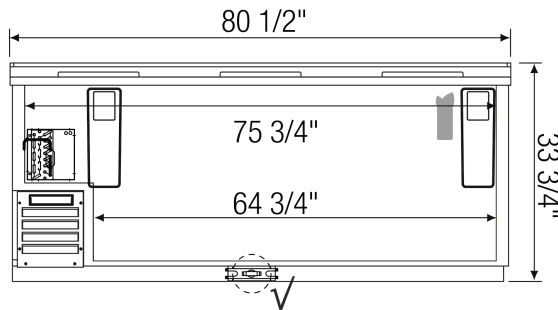

FRONT

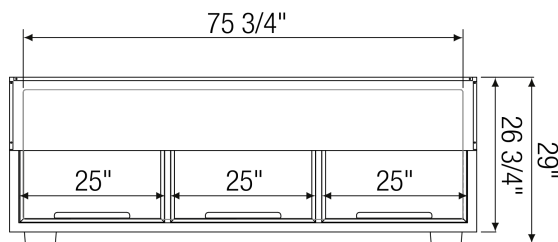

TOP

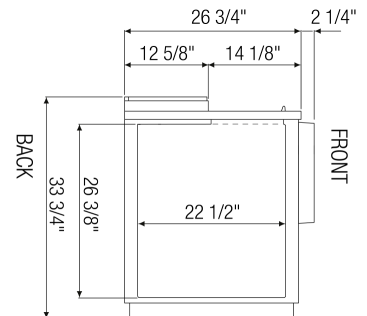

SIDE

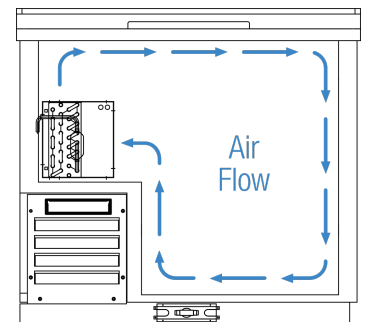

AIRFLOW

ACCESSORIES & OPTIONS

Part Number	Description
AJL03-00	Interchangeable Leg for Caster (Optional)
BCP01-00	24-1/2" x 21" (622mm x 533mm) Epoxy Coating Bottle Cooler Partition
CASA3-02	3" Overall Height Caster Assembly - (3) Front (3) Rear
CASA5-02	5" Overall Height Caster Assembly - (3) Front (3) Rear

(†)Based on evaporating temperature of 23°F (-5°C) & condensing temperature of 131°F (55°C). (▶) Product capacity is calculated based on standard industry figures. (✖) Reference plan view for clarification on caster/unit height. If dimensions and capacity are critical, please contact Everest Refrigeration. Blizzard R290 replacement is at the sole discretion of Everest Refrigeration. Specifications subject to change without notice.