



PROJECT: _____
 ITEM # _____ QTY: _____
 MODEL # _____
 AIA # _____ SIS # _____

UNDERCOUNTER REFRIGERATOR

UNDERCOUNTER REFRIGERATOR

VUR72HC



EXCLUSIVE WARRANTY

- ▶ 7 Year Parts, Labor and Compressor
- ▶ Exclusive 2 Year Warranty On Magnetic Door Gaskets
- ▶ Lifetime Warranty On Handles & Hinges (parts only)



CABINET CONSTRUCTION

- Stainless Steel Exterior (galvanized back and bottom)
- Aluminum Interior
- Stainless Steel 20 Gauge Doors
- One Piece, Snap-In Magnetic Door Gaskets
- 6" Casters Two With Brakes
- 8' Cord And Plug (see electrical data for details)

FEATURES

- Full Electronic Control
- Stay-Open Door Feature For Easy Product Loading
- Heavy-Duty, Spring Loaded Cartridge Hinges
- Low Profile Horizontal Door Handles
- Epoxy Coated Shelves (2 per section)

REFRIGERATION

- Refrigeration System Uses R-290 Refrigerant To Comply With All Environmental Concerns
- Rear Mounted Refrigeration System
- Adaptive Defrost For Reduced Energy Consumption And More Consistent Product Temperatures
- Epoxy Coated Evaporator Coil
- Refrigerator Capable Of Maintaining Product Temperature 36°F To 38°F



Please Verify Qualifying Units By Visiting:
www.energystar.gov/cfs

OPTIONS & ACCESSORIES

- | | | |
|---|--|---|
| • Stainless Steel Interior | • Additional Shelves | • Remote Models* (6" legs only)
(refrigerant must be specified at time of order, see note on back on page) |
| • Stainless Steel Back | • Shelf Clips (set of 4) | |
| • Door Locks | • Casters: 3", Roller Kit, Low Profile | |
| • Door Swing Orientation (at time of order) | • 6" Legs Or 6" Seismic Legs | |
| • Cutting Board | • Correctional Package | |

3779 Champion Blvd, Winston-Salem, NC 27105

ph: (888) 845-9800 | fax: (800) 253-5168

Sales@VictoryRefrigeration.com | VictoryRefrigeration.com

Rev. 7/19/24 Printed in U.S.A.

APPROVAL: _____ DATE: _____

VICTORY UNDERCOUNTER REFRIGERATOR

VUR72HC

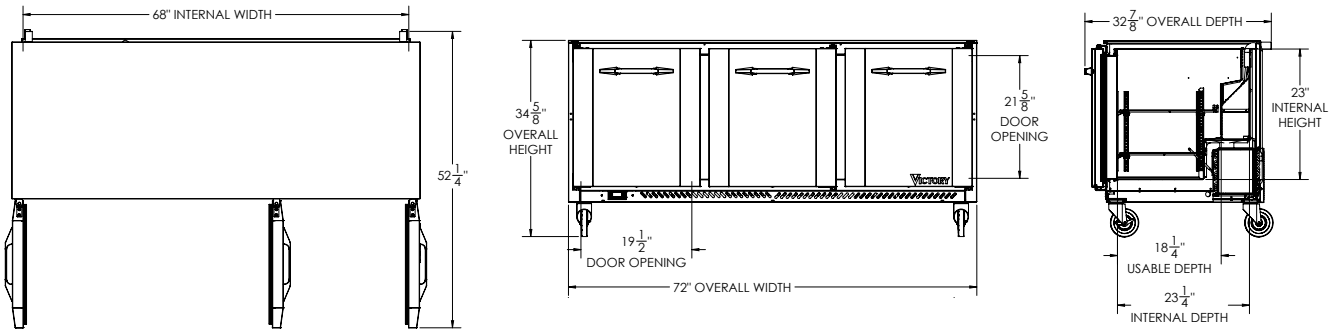

We reserve the right to change specifications and product design without notice. Such revisions do not entitle the buyer to corresponding changes, improvements, additions or replacements for previously purchased equipment. Dimensional tolerances +/- 1/4". Metric dimensions (MM)

3" Bottom & 2" Rear clearance is required

CHARACTERISTICS		ELECTRICAL DATA		SHIPPING DETAILS	
Net Capacity (cubic ft.)	17.88	Cabinet Voltage	115/60/1	Height	49"
Width, Overall (in.)	72"	Total Amperes	3.0	Width	77"
Depth, Overall (with handle)	32 7/8"	NEMA Plug (8' cord)	5-15P	Depth	38"
Height Overall (6" casters)	34 5/8"	REFRIGERATION DATA		Crated Weight	392 lbs
Depth, Door Open 90°	52 1/4"	Condensing Unit Size, HP	1/5	*NOTE: Remote units are field wired and comes with 6" legs. Refrigerant must be specified at time of order.	
Door Opening (in.)	19 1/2" x 21 5/8"	Refrigerant*	R-290		
No. Of Doors/Shelves	3/6	Capacity (BTU/HR) (100°F/20°F)	1350		
		Heat Rejection (BTU/HR)	2025		
		Charge (lbs/grams/ounces)	0.2646 / 120 / 4.24		

3779 Champion Blvd, Winston-Salem, NC 27105 | ph: (888) 845-9800 | fax: (800) 253-5168

Sales@VictoryRefrigeration.com | VictoryRefrigeration.com

Rev. 7/19/24 Printed in U.S.A.