

*Blueair* by  
**BLUENIX**

MODEL BLMT48-HC  
**MEGA TOP  
SANDWICH PREP TABLE**



**Stainless steel cabinet construction**

Stainless steel interior and exterior (galvanized steel back & bottom).



**Temperature range between 33°F ~ 39°F**

Air guard on rear wall ensures proper air circulation and cooling.



**Hydrocarbon refrigerants (R-290)**

Increases energy HFC refrigerants. It is safer for the environment and does not cause ozone depletion.



**Visual and audible door open alarm**

Alarm sounds when doors are not completely closed to protect against food spoilage



**Exterior Dimensions**  
(inches/mm)

L	D	H
48 7/16" 1231 mm	37 21/64" 948 mm	44 11/64" 1122 mm

**Weight**  
(lbs/kg)

<b>Net Weight</b> 227 lbs 103 kg	<b>Ship Weight</b> 289 lbs 131 kg
--	---

## Cabinet construction

- Cyclopentane Insulation – Contains no hydro-fluorocarbons (HFCs) and is environmentally friendly.
- Fans force cold air into this enclosed area keeping stored food items consistently cold
- Insulated pan cover with a stainless steel divider which prevents food spillage into the storage area beneath
- Side rail cutting board bracket with 9 1/2" deep, 1/2" thick cutting board included
- Epoxy coated wire shelves with adjustable shelving height.
- Four 4" Diameter swivel casters with front brakes standard.

## Refrigeration

- Self-contained system, rear mounted compressor.
- Electrodeposition coated evaporator increases performance by maintaining the heat transfer rates over the life of the evaporator and reducing potential corrosion.
- Innovative hot gas frame heating system reduces condensation and increases energy.



Conforms to NSF/ANSI 7(ETL)



Front view

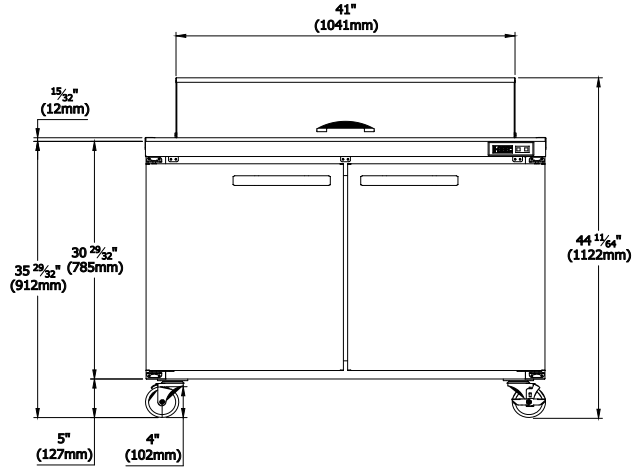

Side view

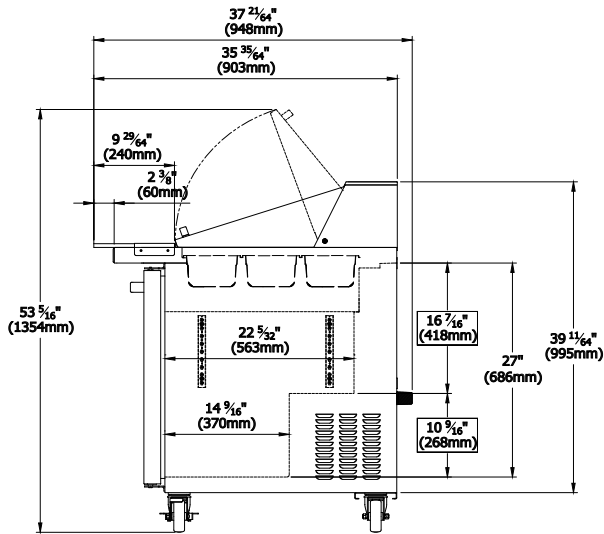

Top view

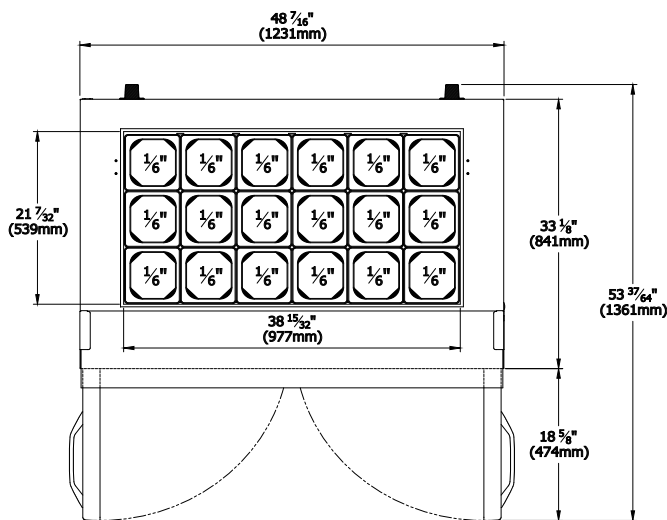

## Doors

- Self-closing doors (doors close at 90° or less)
- Durable door gasket with easy replacement.
- Lifetime guaranteed heavy duty all metal door handles. (Ni-Cr Plated)
- Door designed to open easily.

## Design & Features

- Self-diagnostic digital temperature control & monitor system.
- Digital display allows for easy monitoring.
- Digital controls include automatic evaporator fan motor delay
- Rounded corner design gives a stylish appearance and reduces chances of injury.

## Optional Features & Accessories

- 2.5" diameter casters available.
- Additional shelves are available.

Doors	2
Capacity Cu.Ft.	13.1
Shelves	2
Refrigerant	R-290
Temperature Range	33°F ~ 39°F
Easy Maintenance	Sliding Condensing Unit
Connection	9.8 ft long (3m) flexible three wire cord with modeled plug
HP	1/4
Voltage	115V/60Hz
Amps	4.7
NEMA Config.	NEMA 5-15

Blue Air has right to change specifications without further notice.



- This product may expose you to chemicals including Diisononyl Phthalate(DINP), which is known to the State of California to cause cancer. For more information go to [www.P65Warnings.ca.gov](http://www.P65Warnings.ca.gov).  
 - Ce produit peut vous exposer à des agents chimiques incluant le Diisononyl Phthalate(DINP), reconnu par l'Etat de Californie comme causant le cancer. Pour de plus amples renseignements, consulter le site [www.P65Warnings.ca.gov](http://www.P65Warnings.ca.gov).



[blueairfse.com](http://blueairfse.com)



[orders@blueairfse.com](mailto:orders@blueairfse.com)



1-886-677-8500



223 W. Rosecrans Ave., CA 90248  
T: 310-808-0102

9 W. Shelton Terrace #A, Hillside, NJ 07205  
T: 908-688-0970