



# T&S BRASS AND BRONZE WORKS, INC.

2 Saddleback Cove / P.O. Box 1088  
Travelers Rest, SC 29690

Model No.

**B-0113-ADF10**

Item No.

Travelers Rest, SC: 800-476-4103 • Simi Valley, CA: 800-423-0150 • Fax: 864-834-3518 • www.tsbrass.com

This Space for Architect/Engineer Approval

Job Name \_\_\_\_\_ Date \_\_\_\_\_

Model Specified \_\_\_\_\_ Quantity \_\_\_\_\_

Customer/Wholesaler \_\_\_\_\_

Contractor \_\_\_\_\_

Architect/Engineer \_\_\_\_\_

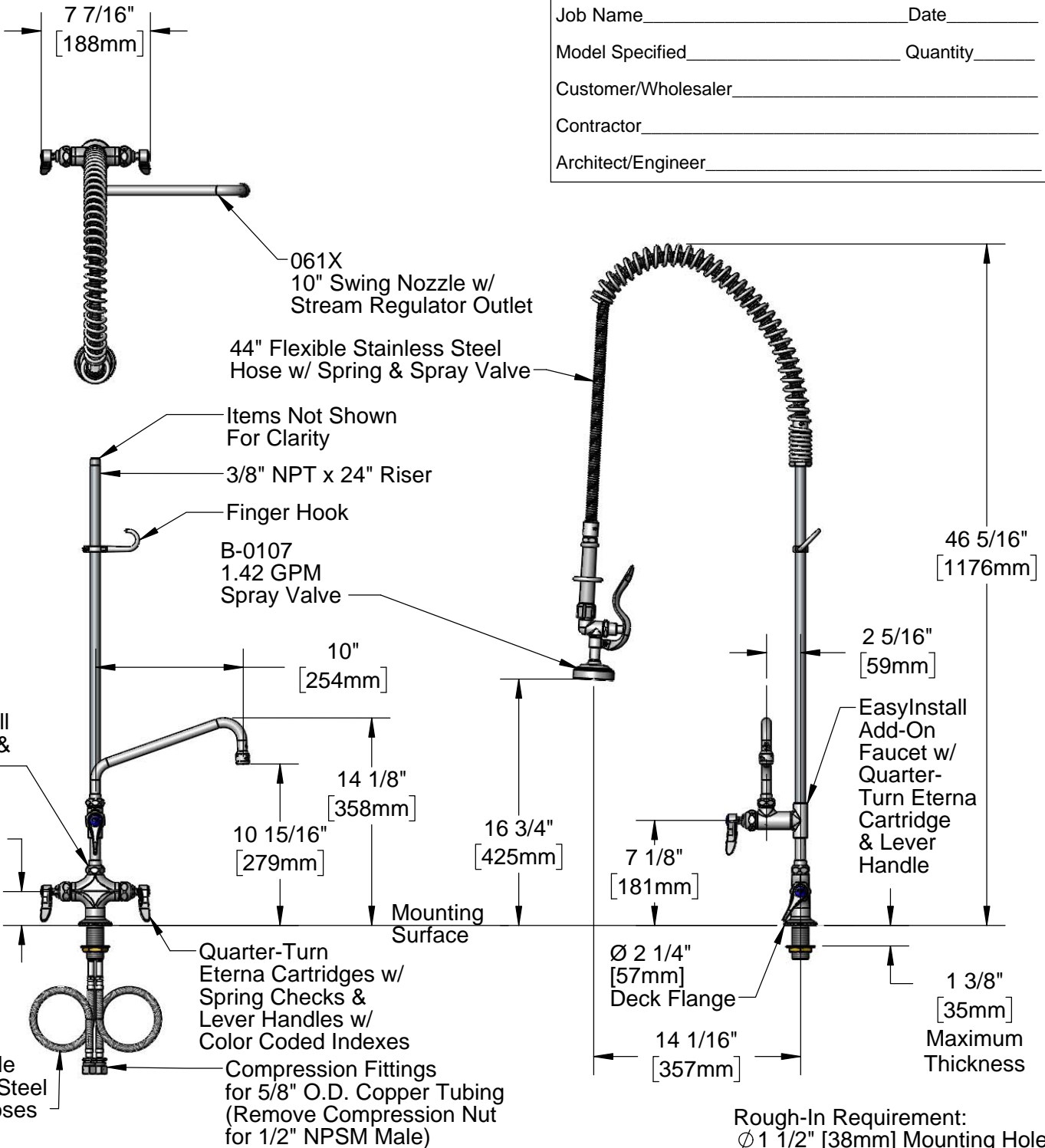

**Product Specifications:**

Pre-Rinse Unit: EasyInstall Single Hole Deck Mount Mixing Faucet, Quarter-Turn Eterna Cartridges w/ Spring Checks, Lever Handles, Add-On Faucet, 10" Swing Nozzle, 44" Flexible Stainless Steel Hose, 1.42 GPM Spray Valve & Flexible Stainless Steel Supply Hoses

**Product Compliance:**

ASME A112.18.1 / CSA B125.1  
NSF 61 - Section 9  
NSF 372 (Low Lead Content)  
EPA Act 2005 (PRSV)



# T&S BRASS AND BRONZE WORKS, INC.

2 Saddleback Cove / P.O. Box 1088  
Travelers Rest, SC 29690

Model No.

**B-0113-ADF10**

Item No.

Travelers Rest, SC: 800-476-4103 • Simi Valley, CA: 800-423-0150 • Fax: 864-834-3518 • www.tsbrass.com

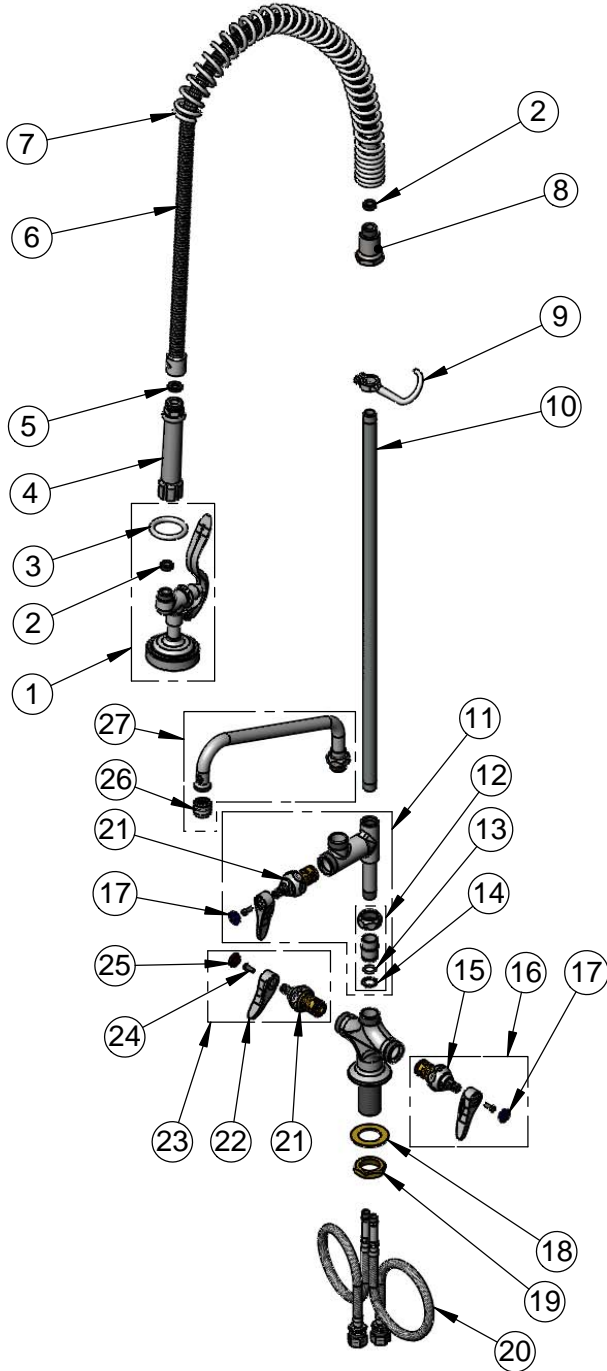

ITEM NO.	SALES NO.	DESCRIPTION
1	B-0107	1.42 GPM Spray Valve
2	010476-45	#27 Washer
3	000907-45	Spray Valve Hold Down Ring
4	002987-40	Grip Handle
5	001014-45	Washer, B-0100 Hose Barrel
6	B-0044-H2A	44" Flexible Stainless Steel Hose, Less Handle
7	000888-45	EasyInstall Overhead Spring
8	000821-40	Spring Body
9	004R	Finger Hook
10	000372-40	3/8" NPT x 24" Riser
11	B-0155-LNEZ	EasyInstall Add-On Faucet w/ Eterna Cartridge & Lever Handle (Less Nozzle)
12	EZ-K	EasyInstall Kit: Nut, Bushing, O-ring & Lock Washer
13	001065-45	O-Ring
14	014200-45	Star Washer, Anti-Rotation
15	012442-40NS	Quarter-Turn Eterna Cartridge w/ Spring Check, LTC
16	002711-40NS	Quarter-Turn Eterna Cartridge w/ Spring Check, Handle, Blue Index & Screw, LTC
17	018506-19NS	Blue Button Index, Press-in
18	002290-45	Lock Washer
19	000965-45	Lock Nut
20	012534-45	18" Flexible Supply Hose (2)
21	012443-40NS	Quarter-Turn Eterna Cartridge w/ Spring Check, RTC
22	001638-45NS	Lever Handle (New Style)
23	002712-40NS	Quarter-Turn Eterna Cartridge w/ Spring Check, Handle, Red Index & Screw, RTC
24	000925-45	Lab Handle Screw
25	001193-19NS	Red Button Index, Press-in
26	B-PT	Full Flow Stream Regulator, 55/64-27
27	061X	8" Swing Nozzle

**Product Specifications:**

Pre-Rinse Unit: EasyInstall Single Hole Deck Mount Mixing Faucet, Quarter-Turn Eterna Cartridges w/ Spring Checks, Lever Handles, Add-On Faucet, 10" Swing Nozzle, 44" Flexible Stainless Steel Hose, 1.42 GPM Spray Valve & Flexible Stainless Steel Supply Hoses

**Product Compliance:**

ASME A112.18.1 / CSA B125.1  
NSF 61 - Section 9  
NSF 372 (Low Lead Content)  
EPA Act 2005 (PRSV)